



A Furukawa Company

Your Optical Fiber Solutions Partner®

## Crimp & Cleave Termination Instructions

for 200  $\mu\text{m}$  and 400  $\mu\text{m}$  ST and SMA Connectors



### For Use With:

200  $\mu\text{m}$  and 400  $\mu\text{m}$  ST and SMA  
Termination Kits

200  $\mu\text{m}$  and 400  $\mu\text{m}$  HCS®  
Fiber-Optic Cable

ST and SMA Crimp & Cleave Connectors

## Important Safety and Warranty Information

---

### Please Read First

Please make sure to **READ** and understand termination instructions completely. Improper assembly will cause poor termination results and cause damage to termination kit components.

Make sure you **WEAR** eye protection during the cleaving process. The bare fiber is sharp and may splinter; handle very carefully. Make sure fiber is disposed of properly, in a hard-sided container.

OFS **WARRANTS** this termination kit to be free of defects for a period of 90 days from the date of purchase. Each kit is qualified at our factory prior to shipment. OFS will, at their discretion, repair or replace any tools found to be defective due to workmanship within the stated warranty period. (Excludes damage to the fiber stripper, cleave tool, and/or diamond blade due to misuse.)

OFS recommends that all replacements or repairs be made at our manufacturing facility, except where specifically outlined. Please **CONTACT** the sales representative in your region or call the factory for technical support:

Mon-Friday, 8:00 am-5:00 pm EST.

**888-438-9936** [Toll free in the US and Canada]

**860-678-0371** [International]

## Table of Contents

---

Content	Page	Content	Page
ST and SMA Termination Kit Contents . . . . .	1	<b>Maintenance &amp; Trouble Shooting Guide</b>	
Related Products and Accessories . . . . .	2-3	Importance of Cleave Tool Cleaning and Maintenance . . . . .	20
ST and SMA Connectors . . . . .	4	Cleave Tool Cleaning Kit . . . . .	20
<b>Termination Instructions</b>		Diamond Blade Replacement Kit . . . . .	20
Step 1: Install strain relief boot . . . . .	5	Trouble Shooting Guide . . . . .	21
Step 2: Strip cable outer jacket . . . . .	5	Termination and Test Kits Available . . . . .	22
Step 3: Strip fiber buffer . . . . .	7	Trademark Information . . . . .	Back Cover
Step 4: Install cable anchor . . . . .	9		
Step 5: Install crimp sleeve . . . . .	10		
Step 6: Install ferrule . . . . .	12		
Step 7: Crimp ferrule . . . . .	13		
Step 8: Cleave fiber . . . . .	16		
Step 9: Position strain relief boot . . . . .	19		
Diamond Cleave Tool Diagram . . . . .	16		

# ST and SMA Termination Kit Contents

## Contents

Part Numbers	Description
DT03732-31	200 $\mu$ m SMA Termination Kit
DT03732-32	200 $\mu$ m ST Termination Kit
DT03732-36	400 $\mu$ m SMA Termination Kit
DT03732-35	400 $\mu$ m ST Termination Kit
AP03317-01	200 and 400 $\mu$ m ST/SMA Instruction Booklet
DT03732-05	SMA 200 $\mu$ m Diamond Cleave Tool (Green Spring)
DT03732-06	ST 200 $\mu$ m Diamond Cleave Tool (Green Spring)
DT03732-09	SMA 400 $\mu$ m Diamond Cleave Tool (Black Spring)
DT03732-10	ST 400 $\mu$ m Diamond Cleave Tool (Black Spring)
AP01224	Cable Stripper
BT03865-03	Crimp Tool (Red Handles)



Termination kit contents  
continues onto the next page →

# ST and SMA Termination Kit Contents continued

- CP01229-02 . . . . . 200 µm Fiber Stripper (White Blade Insert)  
with Cleaning Brush and Prong Tool
- CP01229-04 . . . . . 400 µm Fiber Stripper (Royal Blue Blade Insert)  
with Cleaning Brush and Prong Tool
- AP01225 . . . . . Scissors
- K16248 . . . . . Booklet: Importance of Cleave Tool  
Cleaning and Maintenance

 *Other Items Required (not included in kit): Safety Glasses, Marker*

## Related Products and Accessories Sold Separately

Part Numbers	Description
BT01827	SMA Positioner Plate (use to convert an ST kit to an SMA kit)
BT01900	ST Positioner Plate (use to convert an SMA kit to an ST kit)

### NOTE:

Only one component part replacement is required to convert an ST Termination Kit to its same size equivalent SMA Termination Kit and vice versa.

Kits are not convertible between 200 and 400 µm sizes or vice versa.

P10188-03 ..... Insertion Loss Test Kit for  
..... 200  $\mu\text{m}$  ST Connectors

P10188-04 ..... Insertion Loss Test Kit for  
..... 400  $\mu\text{m}$  ST Connectors

P10188-05 ..... Insertion Loss Test Kit for  
..... 200  $\mu\text{m}$  SMA Connectors

P10188-06 ..... Insertion Loss Test Kit for  
..... 400  $\mu\text{m}$  SMA Connectors

P10188-08 ..... Insertion Loss Test Kit for  
..... 200  $\mu\text{m}$  ST, SMA, V-Pin, and F07 Connectors

P10188-09 ..... Insertion Loss Test Kit for  
..... 400  $\mu\text{m}$  ST, SMA, and V-Pin Connectors

P16247 ..... Cleave Tool Cleaning Kit  
(Includes cleaning fluid and safe cleaning swabs)

AT03290 ..... Diamond Blade Replacement Kit

**Termination kit contents  
continues onto the next page →**

# Related Products and Accessories Sold Separately - continued

## ST and SMA Connectors

Description ..... Part Numbers

### SMA Connectors

200 $\mu$ m Connectors	
for 1.8 mm	BP05061-11
for 2.2 mm	BP05061-12
for 2.5 mm	BP05061-13
for 3.0 mm	BP05061-14
400 $\mu$ m Connectors	
for 1.8 mm	BP05061-41
for 2.2 mm	BP05061-42
for 2.5 mm	BP05061-43
for 3.0 mm	BP05061-44

### ST Connectors

200 $\mu$ m Connectors	
for 1.8 mm	BP05065-11
for 2.2 mm	BP05065-12
for 2.5 mm	BP05065-13
for 3.0 mm	BP05065-14
400 $\mu$ m Connectors	
for 1.8 mm	BP05065-41
for 2.2 mm	BP05065-42
for 2.5 mm	BP05065-43
for 3.0 mm	BP05065-44

SMA Connector

ST Connector

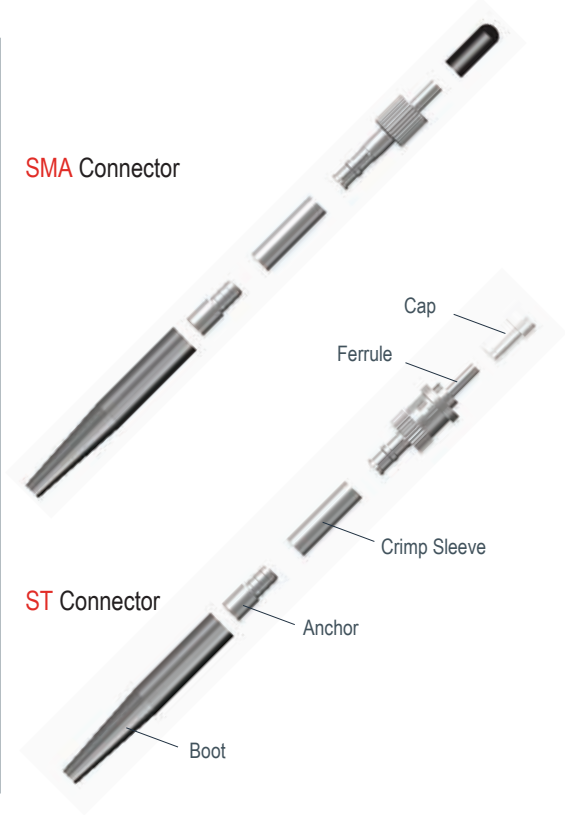

# Termination Instructions

## STEP 1

### Install Strain Relief Boot

- Slide STRAIN RELIEF BOOT (tapered end first) onto cable and move up and out of the way for easy stripping.



## STEP 2

### Strip Cable Outer Jacket

- Mark cable outer jacket 2½ inches from the end with a marker.

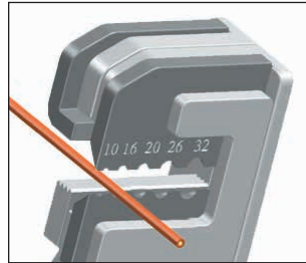

### NOTE:

The tapered end of the boot may be trimmed with a scissors to suit larger diameter cable.

Step 2 continues  
onto the next page →



# Termination Instructions

## STEP 2

### Strip Cable Outer Jacket continued

- Select appropriate hole on CABLE JACKET STRIP TOOL to suit cable outer jacket diameter. (See chart at right)

Cable Size	Stripping Hole
1.8 mm	1.0
2.2 mm	1.6
2.5 mm	1.6
3.0 mm	2.0

- Using the CABLE JACKET STRIP TOOL, apply quick squeezing action, release and remove the 2 1/2 inches of cable outer jacket.

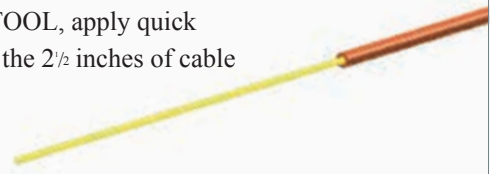

- Verify proper strip length against the strip template shown below.

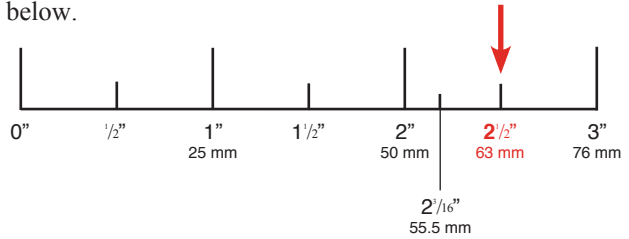

### NOTE:

If cable outer jacket is difficult to remove in one step, it may be removed in shorter sections.

## STEP 3

### Strip Fiber Buffer

#### ! Before you start:

Make sure to use the appropriate strip tool insert for the buffer removal process:  
200  $\mu\text{m}$  = WHITE blade inserts  
400  $\mu\text{m}$  = ROYAL BLUE

Be careful while handling the FIBER STRIPPER. Handle as a precision device and do not strike on hard surfaces or drop.

Be sure to clean blades frequently using small bristle brush supplied.

**IMPORTANT:** Pull straight when stripping the fiber buffer.  
The HCS fiber cladding can be damaged if fiber is not pulled straight.

- Separate buffered fiber from yellow aramid yarn by pulling back along the cable.

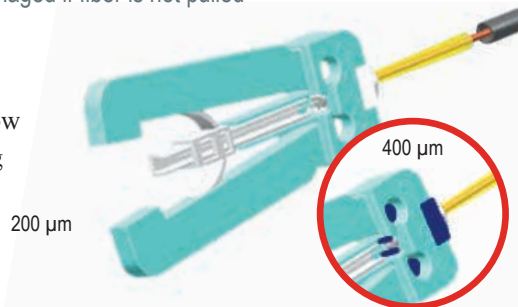

**Step 3 continues  
onto the next page →**

#### **NOTE:**

Be careful not to touch the HCS fiber coating once the fiber has been stripped. The coating will retain finger oils which can transfer to and damage the gripper pads in the cleaver during Step 8 in the termination process.

## Termination Instructions

### STEP 3

#### Strip Fiber Buffer continued

- Insert the buffered fiber through the guide tube of the fiber stripper until the cable outer jacket bottoms out in the tube.
- Holding cable securely, squeeze handles to cut buffer and **PULL STRAIGHT** to remove buffer.
- Inspect HCS cladding for damage from improper buffer stripping. (i.e. white dusty stripe)
- Verify proper buffer strip length to be  $2\frac{7}{16}$  inches.

#### **NOTE:**

If unable to insert buffered fiber through guide tube, trim tip of the fiber using scissors. If a short length of cable is being terminated, wrap the cable around your finger to prevent fiber and aramid yarn from pulling out of cable jacket.

#### **NOTE:**

If damage is visible cut off the damaged fiber and repeat the procedure from Step 2: Strip Cable Outer Jacket.

## STEP 4

### Install Cable Anchor

- Pull aramid yarn strands back over stripped fiber.

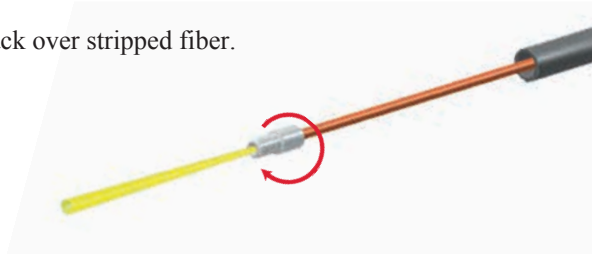

- Holding aramid yarn and fiber at very top. Feed the fiber and the aramid yarn through the CABLE ANCHOR. Bottom out the anchor on the cable outer jacket using a clockwise turning motion. (i.e. screw the anchor onto the cable outer jacket, if necessary)

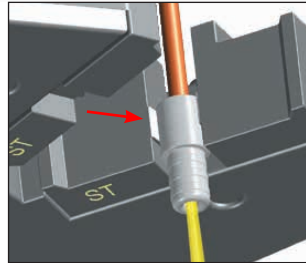

- Position anchor in CRIMP TOOL, such that the end of the anchor aligns with the edge of the crimp die.
- Squeeze crimp tool handles together until it clicks, then releases.

### NOTE:

Be careful not to touch the HCS fiber coating once the fiber has been stripped. The coating will retain finger oils which can transfer to and damage the gripper pads in the cleaver during Step 8 in the termination process.

## Termination Instructions

### STEP 5

#### Install Crimp Sleeve

- Divide the aramid yarn into approximately two equal halves.

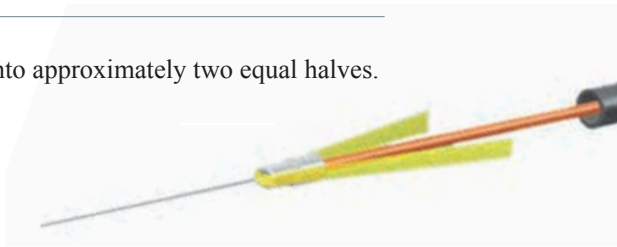

- Fold both halves of the aramid yarn back over the cable anchor. Be sure the fiber is centered in the cable anchor.

- Slide the CRIMP SLEEVE over the cable anchor and aramid yarn until it bottoms out on the cable anchor.



- Position the crimp sleeve in the CRIMP TOOL such that:

~ The back edge of the crimp sleeve is aligned with the edge of the crimp nest.

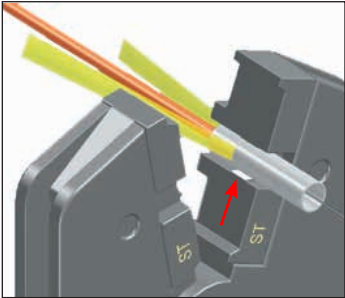

~ The aramid yarn halves are positioned over the jaws.

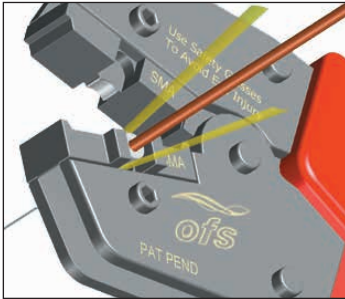

## Termination Instructions

### STEP 6

#### Install Ferrule

- Feed fiber through hole in rear of FERRULE.

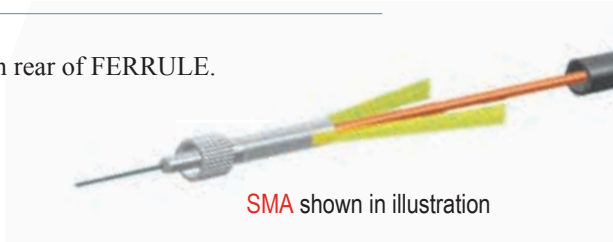

- Slide the ferrule for either SMA or ST connector down the fiber and into the crimp sleeve. Push the ferrule firmly until it bottoms out in the crimp sleeve.

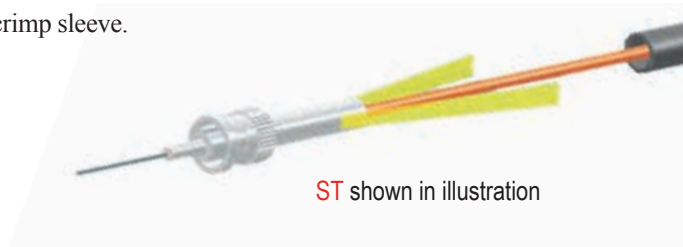

## STEP 7

### Crimp Ferrule

---

#### **!** Before you start:

Make sure the ferrule is fully seated in the crimp sleeve.

Check to make sure the crimp die is stamped properly for the connector type, 'SMA' on one side and 'ST' on the other.

Proper positioning of the connector in the die set is critical for a proper crimp location. Failure to crimp in the prescribed location will result in poor connector retention strength.

Crimp dies can be reversed at the factory for left-handed operators.

**Step 7 continues  
onto the next page →**



## Termination Instructions

### STEP 7

#### Crimp Ferrule continued

##### SMA Connector

- Position the back of the SMA COUPLING NUT against the side of the crimp die set stamped 'SMA' as shown.
- Rotate the SMA connector so that its location dimple is oriented in the crimp die set as shown.
- Squeeze CRIMP TOOL handles together until the tool releases.

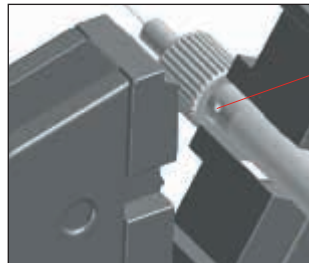
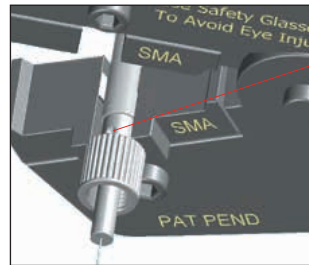

## ST Connector

- Position the back of the ST COUPLING NUT against the side of the crimp die set stamped 'ST'.

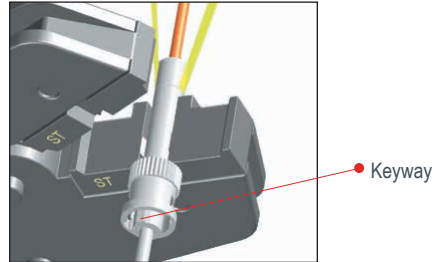

- Rotate the ST connector so that its key is oriented in the crimp die set as shown.
- Squeeze CRIMP TOOL handles together until the tool releases.

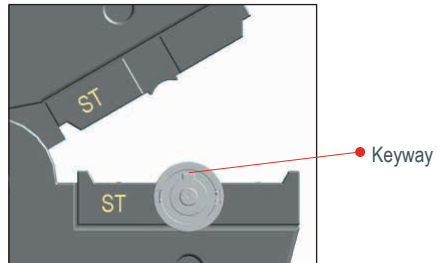

## Termination Instructions

### STEP 8

#### Cleave Fiber



#### Before you start:

Make sure the appropriate cleave tool positioner plate is being used: **SMA** or **ST**

Make sure the appropriate colored tension spring is being used: **200  $\mu\text{m}$  = GREEN** **400  $\mu\text{m}$  = BLACK**

Refer to diagram of the Cleave Tool.

Careful while handling the Cleave Tool. Handle as a precision device and do not strike on hard surfaces or drop.

Keep the cleave tool clean and free from oils, including naturally occurring finger oils. Gripper pads, diamond blade and anvil should be cleaned after every 50 cleaves. Use the OFS Cleave Tool Cleaning Kit — Part #P16247 - available separately.

Do not use alcohol to clean the diamond blade or the gripper pads. Alcohol will chemically react with the gripper pads and ruin them.

Do not insert metal tools near the diamond blade, as it is fragile and may chip.

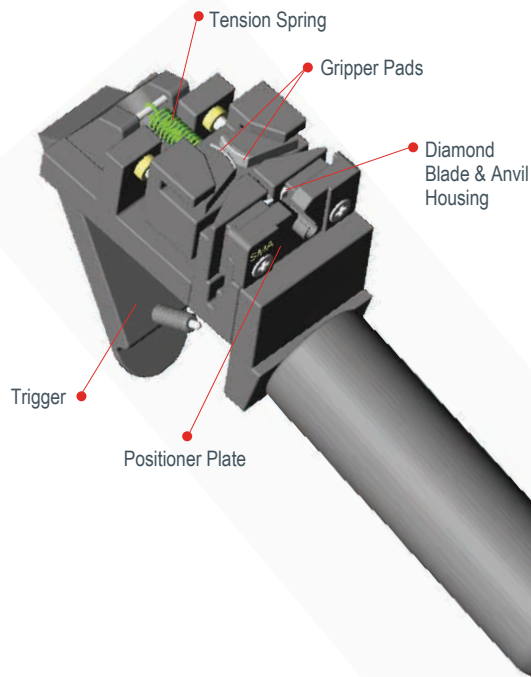

- Holding the CLEAVING TOOL in a horizontal position, grip the handle while leaving your index finger free to actuate trigger.

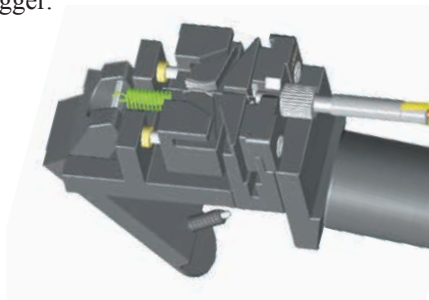

- Place the ferrule into the hole of the positioner plate until it is fully inserted.
- Release the connector in the tool.

**NOTE:**

It is critical to fully insert the connector into the positioner plate. Failure to do so, may cause poor cleave quality and/or damage to the diamond blade.

**NOTE:**

Do not hold onto the connector during the cleave process. Doing so may cause poor cleave quality.

## Termination Instructions

---

### STEP 8

#### Cleave Fiber (continued)

---

- Using index finger, slowly and gently depress trigger to perform the cleave process. The cleave process is complete when the fiber snaps away from the connector. Do not release trigger!
- Before releasing the trigger, remove the connector from the cleave tool and grasp the top of the scrap fiber while releasing the trigger. Gently remove the scrap fiber while keeping it away from the diamond blade.
- Dispose of scrap fiber safely in a hard-sided container.
- Install protective cap onto connector to protect cleaved fiber surface.

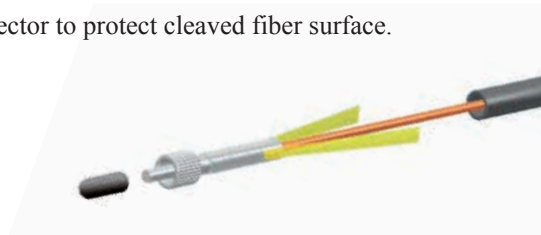

#### NOTE:

It is critical to fully insert the connector into the positioner plate. Failure to do so, may cause poor cleave quality and/or damage to the diamond blade.

## STEP 9

### Position Strain Relief Boot

- Using scissors, trim exposed aramid yarn as close to sleeve as possible.



- Slide strain relief boot onto connector (up to rear of coupling nut) to complete termination.



## Maintenance & Trouble Shooting Guide

---

### Importance of Cleave Tool Cleaning and Maintenance

The Cleave Tool supplied with OFS's Termination Kits contains movable parts, wear items, and a diamond blade that require regular maintenance, care, or replacement after useful life in order to perform satisfactorily. Damage and parts replacement expense can result if recommended procedures are not followed.

- ~ The diamond blade must be cleaned; the gripper pads must be cleaned, kept oil-free, and replaced after wear.
- ~ The cleave-tool trigger must be depressed slowly.

### Cleave Tool Cleaning Kit

For cleaning your cleave tool, please order the OFS Cleave Tool Cleaning Kit (part #P16247) which includes recommended cleaning fluid, swabs, and complete instructions.

### Diamond Blade Replacement Kit

For replacing the diamond blade/anvil assembly, please order the Diamond Blade Replacement Kit (Part #AT03290.) The kit includes a new diamond blade, anvil, replacement screws, and complete instructions for performing this simple procedure at your facility.

## Trouble Shooting Guide

Problem	Dim-light termination/ no light termination	Poor cleave quality / High insertion loss	Fiber does not cleave	Fiber protrudes or recesses after cleave
Possible Explanations	<p>Improper strip technique <i>Refer to Steps 2 &amp; 3</i></p> <p>Improper crimp position <i>Refer to Steps 4 - 7</i></p>	<p>Improper crimp position <i>Refer to Steps 4 - 7</i></p> <p>Improper cleave techniques <i>Refer to Step 8</i></p> <p>Incorrect tooling for fiber size or connector type <i>Refer to Page 1</i></p> <p>Diamond blade needs to be cleaned or replaced <i>Refer to Page 20</i></p> <p>Gripper pads worn and need to be replaced <i>Call Tech Support to place a purchase order for service.</i></p>	<p>Fiber has not been first thoroughly stripped <i>Refer to Step 3</i></p> <p>Improper cleave techniques <i>Refer to Step 8</i></p> <p>Incorrect tooling for fiber size or connector type <i>Refer to Page 1</i></p> <p>Diamond blade needs to be cleaned or replaced <i>Refer to Page 20</i></p> <p>Gripper pads worn and need to be replaced <i>Call Tech Support to place a purchase order for service.</i></p>	<p>Improper crimp position <i>Refer to Steps 4 - 7</i></p> <p>Improper cleave techniques <i>Refer to Step 8</i></p> <p>Incorrect tooling for fiber size or connector type <i>Refer to Page 1</i></p> <p>Gripper pads worn and need to be replaced <i>Call Tech Support to place a purchase order for service.</i></p>



## Termination and Test Kits Available

---

OFS offers a specialized Termination Kit—and associated Insertion Loss Test Kit—for each type of Crimp & Cleave connector we support. These kits are available in various combinations of sizes and/or connector types. Customer Relations at our factory can help you select the correct kit for your purposes.

This document is for informational purposes only and is not intended to modify or supplement any OFS warranties or specifications relating to any of its products and services.

Copyright © 2014 OFS Fitel, LLC.  
All Rights Reserved.

0814



*A Furukawa Company*

55 Darling Drive, Avon, CT 06001

**To learn more, please call or visit our website.**

Phone: **1 860 678 0371**

Toll Free: **1 888 438 9936**

Web: **[www.ofsoptics.com](http://www.ofsoptics.com)**

**AP03317-01 Rev. M**

## **Trademark Information:**

Manufactured in the USA by OFS.

HCS is a registered trademark in the USA of OFS Fitel, LLC.