

Table of Contents

1. General	2
2. Precautions	3
3. Cable and Fiber Preparation	3
3.1 Coated Fiber	3
3.2 Buffered Fiber Cable (Premises/Building)	4
3.3 Jacketed Fiber Cable (3.0 mm)	5
4. Adhesive and Primer Preparation	6
5. Connector Installation	6
5.1 Connector –Buffered Fiber Assembly	6
5.2 Connector – Jacketed Fiber Cable Assembly (3.0 mm)	7
6. Cleaving and Polishing	9
6.1 Cleaving the Fiber	9
6.2 Polishing SC Connector Ends	9
7. Inspection	12
7.1 Using Microscope to Inspect Fiber	12
7.2 Repairs	12
7.3 Snap On Connector Grip	12
8. Interconnecting with SC Fiber Optic Connectors	13
8.1 Cleaning Connector and Coupling	13
8.2 Installing Coupling on SC Connectors	13
9. Ordering Information	14
9.1 Tool Kits	14
9.2 Consumables	15
9.3 SC Connectors	16
9.4 Couplings (Standard)	16
10. Assistance Information	16

**640-252-049-02-UNIV
Instruction Sheet**

1. General

The 1032F1 Tool Kit contains tools to assemble SC and ST Connectors onto building cable and 1.6 and 3.0-mm cordages. The 1032F1 Kit is identical to the 1032B5 Kit except the 200A Curing Oven is omitted.

The 1032H Tool Kit contains tools for installing SC, ST, and LC Connectors onto 0.9-mm buffered fibers. Required consumables are sold separately.

The Universal Polishing Kit (for pre-radiused connectors) contains polishing paper and other materials required to assemble connectors. (Note: The kit does not include adhesive). See the table below for proper applications.

The assembled SC Fiber Optic Connector is intended for use in Local Area Networks (LANs), Premises Distribution Systems (PDSs), fiber to the home, and other applications where quality, small-size, low-loss, and low-cost connections are required.

Ordering Information for the 1032() Kits and the SC Connector assembly is provided in **Section 9**.

Recommended usage temperature for primer and adhesive used in these procedures.		
Storage	-5°C to 30°C	23°F to 86°F
Installation	0°C to 38°C	32°F to 100°F
Operating	-40°C to 75°C	-40°F to 167°F

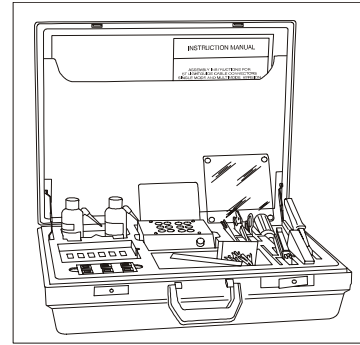

Figure 1. 1032() Tool Kit

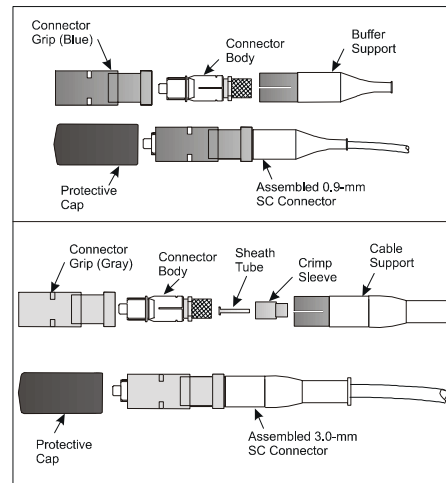

Figure 2. SC Fiber Optic Connectors

Table 1. Connector Product Description

Connector Code	Type Mode	Buffer or Jacket Size (mm)	End Face Geometry	Univ. Consumable Kit	Tool Kit Required 1032()
P6200A-Z-125	MM	1.6, 3.0	Domed	300486552	B5 or B6
P6201A-Z-125	MM	0.9	Domed	300486552	B5 or B6
P6000A-Z-125	SM	0.9, 1.6, 3.0	Domed	300472651	B5 or B6
P6001A-Z-125	SM	0.9	Domed	300472651	B5 or B6

Note 1: When using 250- μ m coated fiber, also use D-181755 Consumable Kit (see Section 3.1).
Note 2: Jacketed Fiber Cable (Cordage) Compatibility: The SC connector should only be installed onto 3.0 mm 9000 Series cordage containing stiff nylon buffered fibers. The SC connector will not function properly when installed onto cordages with soft PVC buffered fibers.

2. Precautions

- Safety glasses should be worn at all times while performing the installation procedures.
- Avoid skin contact with epoxy adhesive.
- When the heater is in operation, place it away from combustibles.
- Disconnected optical connectors may emit radiation if the far end is coupled with a working laser or Light-Emitting Diode (LED). Do not view the fiber end of a cable or plug with an optical instrument until absolute verification is established that the fiber is disconnected from any laser or LED source.
- For cleaning of these fiber optic products, always use Isopropyl Alcohol (>91% 2-Propanol + water).
- It is recommended that you use the E-Series Ultrajet[®] duster from Chemtronics[®], Inc. when canned air is required.

3. Cable and Fiber Preparation

3.1 Coated Fiber

Note: Use the appropriate procedures for preparing outside plant (OSP) cable. See 636-299-110 for more information on grounding, blocking, and buffering Fiber Optic Cable.

Important: Do not attempt to remove the fiber coating until a buffer tube has been placed over the coated fiber. This will prevent cutting the fiber by mistake.

1. **EXPOSE AN APPROPRIATE LENGTH OF COATED FIBER** (as specified in the D-181755 Kit) to allow for connector installation and termination.
2. **PLACE AN APPROPRIATE LENGTH OF BUFFERED TUBING** from the D-181755 Kit over the fiber to be stripped.
3. **PLACE BUFFER SUPPORT ONTO FIBER** Slip the buffer support onto the buffer tube covering the fiber (Figure 3).

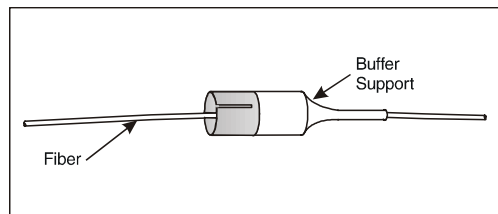

Figure 3. Install Buffer Support on Buffer Tubing

4. **REMOVE FIBER COATING** With the stripper handles open and the buffered tube aligned with the end of the fiber, insert both fiber and buffer tubing through the guide tube opening enough to allow about 0.75 inch (19.0 mm) of buffer and fiber coating to be removed (Figures 4 and 5).
5. Close the handles and pull the buffer away from the tool with a smooth motion.
6. Wipe the stripped fiber with a wipe dampened with isopropyl alcohol to remove any residual coating.

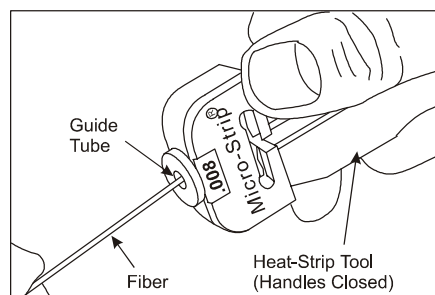

Figure 4. Heat-Strip Tool - Removing Fiber Coating from Buffered Fiber

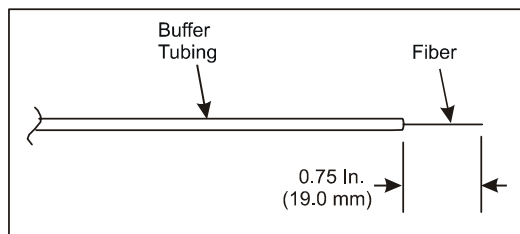

Figure 5. Recommended Strip Dimensions for Singlemode and Multimode Connectors

7. **INSTALL CONNECTOR ON FIBER** Use the procedures outlined in **Connector Installation, Section 5.1**, in this manual to complete installation of the connector, cure the adhesive, polish and inspect the fiber end.

* Ultrajet and Chemtronics are registered trademarks of Chemtronics, Inc.

3.2 Buffered Fiber Cable (Premises/Building)

1. **REMOVE OUTER JACKET** Using the R-4366 sheath removal tool, ring-cut the outer sheath the required distance from the cable end and remove outer jacket. Typical length is approximately 24 to 36 inches (0.61 to 0.91 meters).

IMPORTANT: Do not cut into fibers.

Note 1: The exposed buffered fiber should be long enough to:

- Allow for placement into the equipment cabinet
- Allow access during the polishing process
- Prevent stress on the fiber during connector application.

Note 2: See Table 1, page 1, to verify correct connector choice for cable type.

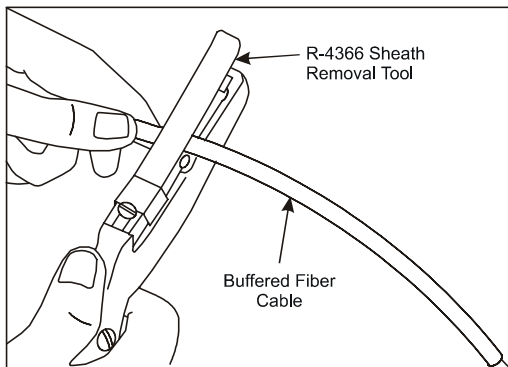

Figure 6. R-4366 Sheath Removal Tool - Ring-Cut Cable Jacket

2. **PLACE BUFFER SUPPORT ONTO CABLE**
Slip the buffer support onto the buffered fiber.

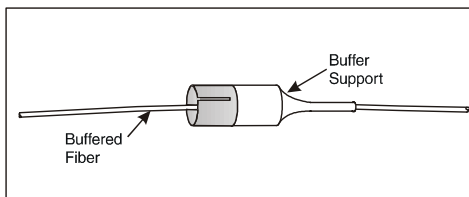

Figure 7. Install Buffer Support on Buffered Fiber

3. **MEASURE AND MARK THE BUFFERED FIBER** 0.75 inch (19.0 mm) from the end.
4. **REMOVE BUFFER AND FIBER COATING**

- Refer to 1026A Heat-Strip Tool Operating Instructions for setup. Make sure heater unit is fully inserted.
- Insert buffered fiber through the guide tube to allow 0.75 inch (19 mm) of the buffer and coating to be removed.
- Close the handles and wait 6 to 10 seconds for softening of the buffer to occur. Pull the fiber from the tool with one smooth motion.
- Wipe the stripped fiber once with a wipe dampened with isopropyl alcohol to remove any residual coating.

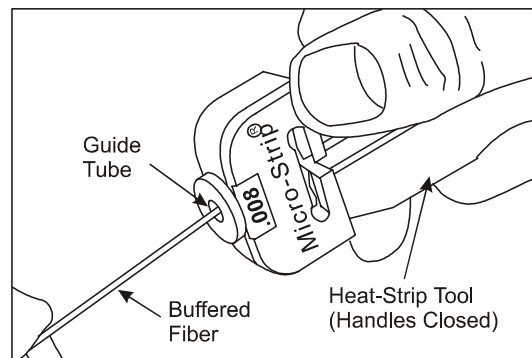

Figure 8. Heat-Strip Tool - Removing Fiber Coating from Buffered Fiber

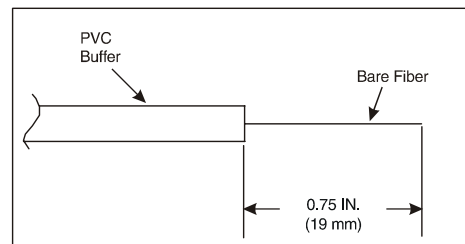

Figure 9. Buffered Fiber Stripping Dimensions

5. **SET ASIDE THE PREPARED FIBERS**
Place the prepared fiber into the grooves of the 971A holder block (provided with the tool kits).

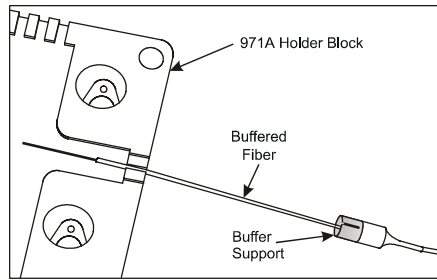

Figure 10. 971A Holder Block with Buffered Fiber

- INSTALL CONNECTOR ON FIBER** Use the procedures outlined in Connector Installation, Section 5.1, to complete the installation of the connectors, cure the adhesive, polish and inspect the fiber end.

3.3 Jacketed Fiber Cable (3.0 mm)

Note: See Table 1, Note 2 on page 1 before proceeding.

- PLACE CABLE SUPPORT AND SLEEVE ONTO CABLE** Slip the cable support and the crimp sleeve onto the cable.

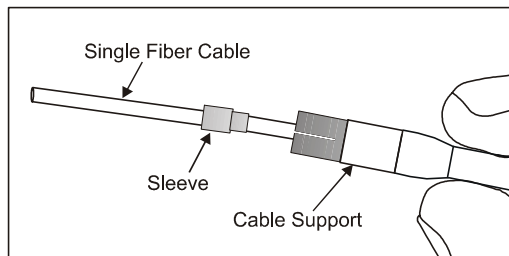

Figure 11. Cable Support and Sleeve on Single Fiber Cable

- MEASURE AND MARK CABLE** Using either a scale or template, measure and mark the cable 1.35 inches (34.3 mm) from the end of the cable.
- REMOVE OUTER JACKET** Using the Number 1 notch on the blue-handled 700A stripping tool, remove the outer jacket back to the mark.

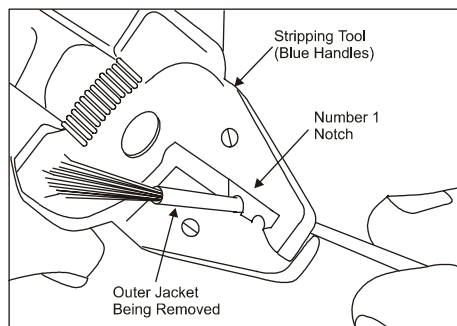

Figure 12. Stripping Outer Jacket of Single Fiber Cable

4. INSERT SHEATH TUBE INTO CABLE JACKET

For 3.0-mm cable, insert the sheath tube over the buffered fiber and into the cable jacket.

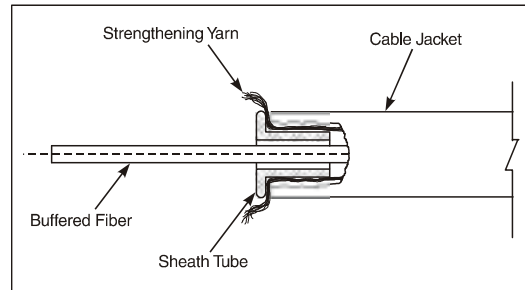

Figure 13. Sheath Tube Insertion 3.0 mm

- CUT STRENGTHENING YARN** With the strengthening yarn separated into two equal size bundles, use scissors to trim the strands 0.25 inch (6.4 mm) from the edge of the outer jacket. Flair the strengthening yarn evenly all around the cable.

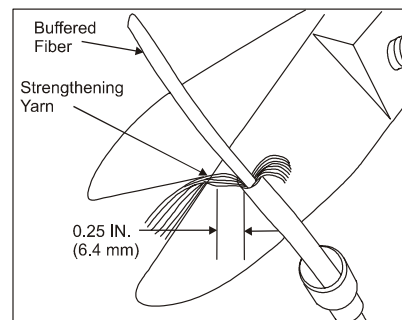

Figure 14. Cutting Strengthening Yarn - Single Fiber Cable

- MEASURE AND MARK BUFFERED FIBER** Measure and mark the buffered fiber 0.75 inch (19 mm) from the end of the buffered fiber.

7. REMOVING BUFFER AND FIBER COATING

- Refer to 1026A Heat-Strip Tool Operating Instructions for setup. Make sure heater unit is fully inserted.
- Insert buffered fiber through the guide tube to allow 0.75 inch (19 mm) of the buffer and coating to be removed.
- Close the handles and wait 6 to 10 seconds for softening of the buffer to occur. Pull the fiber from the tool with one smooth motion.
- Wipe the stripped fiber with a wipe dampened with isopropyl alcohol to remove any residual coating.

640-252-049-02-UNIV
Instruction Sheet

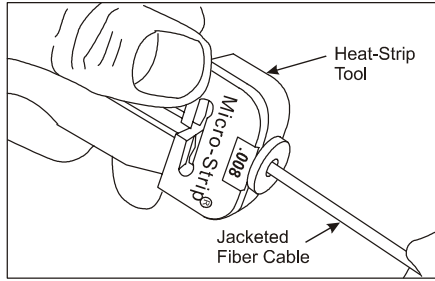

Figure 15. Heat-Strip Tool - Jacketed Fiber Cable

RECOMMENDED DIMENSIONS FOR 9000 SERIES CORDAGE

The recommended dimensions for the prepared cable and fiber are shown in Figure 17.

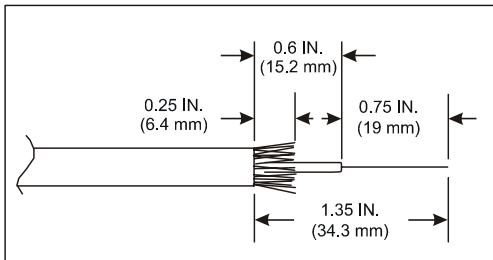

Figure 16. Recommended Dimensions for MiniCord™ Cable and 9000 Series Cordage

8. **SET ASIDE PREPARED CABLE** Place the prepared cable into the grooves of the 971A holder block provided with the tool kit.

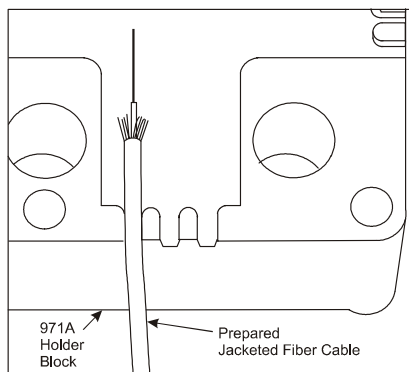

Figure 17. 971A Holder Block with Jacketed Fiber Cable

9. **INSTALL CONNECTOR ON FIBER** Use the procedures outlined in Connector Installation, Section 5.2, to complete the installation of the connector, cure the adhesive, polish and inspect the fiber end.

4. Adhesive and Primer Preparation

Note: Use adhesive Comcode 106 730 856 and primer Comcode 106 730 849.

PREPARE ADHESIVE by shaking the bottle of adhesive vigorously.

- Remove the cap from the bottle of adhesive. If the adhesive has not been opened, use a straight pin to make a hole in the tip of the nozzle.
- Twist a syringe tip onto the nozzle of the adhesive bottle making sure that tip fits snugly.

PREPARE PRIMER by shaking the bottle of primer vigorously.

- Remove the cap from the bottle of primer. If the primer has not been opened, use a straight pin to make a hole in the tip of the nozzle.
- Twist a syringe tip onto the nozzle of the primer bottle making sure that the tip fits snugly.

5. Connector Installation

5.1 Connector –Buffered Fiber Assembly

1. **APPLY THE PRIMER TO FIBER BUFFER** Using the syringe with the primer in it, apply primer to 0.25 inch of the buffer. Avoid getting the primer on the bare fiber. If several connectors are being terminated, it is recommended that all of the buffers be primed before moving on to the next step.

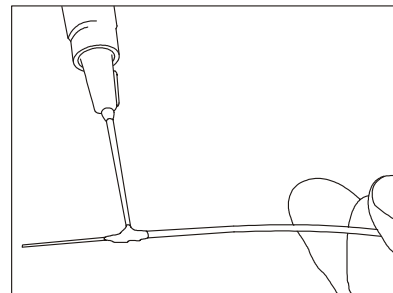

Figure 18. Apply Primer to Buffer

2. **PREPARE CONNECTOR TIP** Make sure that the hole in the connector tip is clear of any foreign matter. Use music wire to clear the hole if necessary. Place a wipe on the work table. Using the syringe, place a drop of primer on the wipe. Wipe the end of the connector through the primer on the wipe one time.
3. **INJECT ADHESIVE INTO CONNECTOR** Gently insert the syringe tip on the adhesive through the tubing in the back of the connector until it bottoms and inject the adhesive into the connector until a bead of adhesive forms on the tip of the ferrule. The adhesive bead should cover at least one-half of the ferrule end face. Withdraw the syringe tip from the connector, but maintain pressure on the bottle or syringe to coat the inside diameter of the metal ferrule flange (barrel) with the adhesive. (**Note: Do not fill the plastic tubing with adhesive. Do not allow the adhesive to get onto the connector housing components.**)

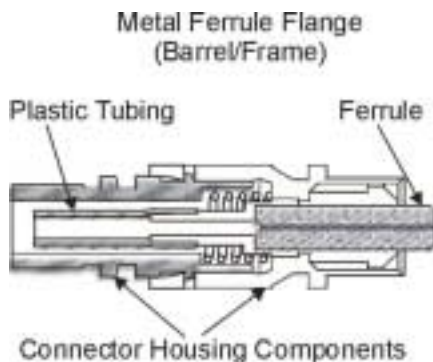

Figure 19. SC Connector Components.

4. **IMMEDIATELY INSERT THE FIBER** through the connector, carefully feeling for the ferrule capillary. Rotate the connector as the fiber is inserted to allow the fiber to pass through the connector without hanging up. Once the fiber has been fully inserted, use the syringe to place a drop of primer over the bead of adhesive on the ferrule end face. Be careful not to break the fiber. Seat the fiber into the connector making sure the buffer is completely seated against the ceramic inside the connector.

5. **INSTALL CONNECTOR HOLDER** Place the connector in a 1510C Connector Holder. Be careful not to break the fiber.

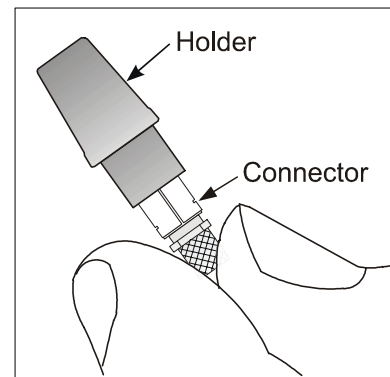

Figure 20. Install Connector Holder

6. **INSTALL BUFFER SUPPORT** Slide and snap the buffer support onto the back of the connector. Make sure the fiber is fully seated into the connector and place a micro clip (1043A Tool) on the buffer support to make sure the fiber is not inadvertently pulled out of the connector.

Important: Use only the connector or buffer support when handling the connector assembly. Make sure that the buffered fiber is fully inserted into the connector. Place a micro clip on the buffer support as shown. This inhibits the buffered fiber from being accidentally pulled out of the connector.

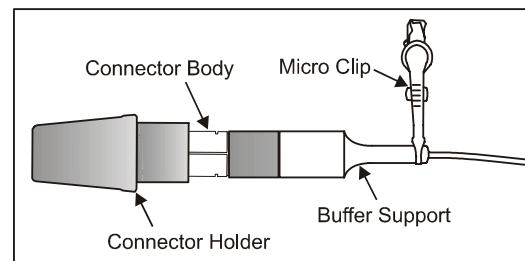

Figure 21. Install Buffer Support and Micro Clip

7. **ALLOW ADHESIVE TO CURE** Place the assembly in the 971A Holder Block. Allow the adhesive to cure at least 1 minute.

5.2 Connector – Jacketed Fiber Cable Assembly (3.0 mm)

1. **APPLY THE PRIMER TO FIBER BUFFER** Using the syringe with the primer in it, apply primer to 0.25 inch

**640-252-049-02-UNIV
Instruction Sheet**

of the buffer. Avoid getting the primer on the bare fiber. If several connectors are being terminated, it is recommended that all of the buffers be primed before moving on to the next step.

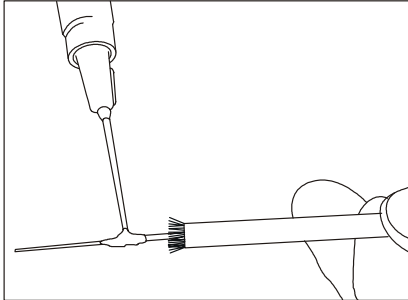

Figure 22. Apply Primer to Buffer

2. **PREPARE CONNECTOR TIP** Make sure that the hole in the connector tip is clear of any foreign matter. Use music wire to clear the hole if necessary. Place a wipe on the work table. Using the syringe, place a drop of primer on the wipe. Wipe the end of the connector through the primer on the wipe one time.

3. **INJECT ADHESIVE INTO CONNECTOR** Gently insert the syringe tip on the adhesive through the tubing in the back of the connector until it bottoms and inject the adhesive into the connector until a bead of adhesive forms on the tip of the ferrule. The adhesive bead should cover at least one-half of the ferrule end face. Withdraw the syringe tip from the connector, but maintain pressure on the bottle or syringe to coat the inside diameter of the metal ferrule flange (barrel) with the adhesive. **(Note: Do not fill the plastic tubing with adhesive. Do not allow the adhesive to get onto the connector housing components.)**

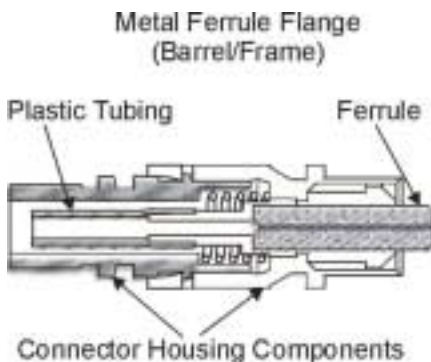

Figure 23. SC Connector Components.

4. **IMMEDIATELY INSERT THE FIBER** through the connector, carefully feeling for the ferrule capillary. Rotate the connector as the fiber is inserted to allow the fiber to pass through the connector without hanging up. Once the fiber has been fully inserted, use the syringe to place a drop of primer over the bead of adhesive on the ferrule end face. Be careful not to break the fiber.

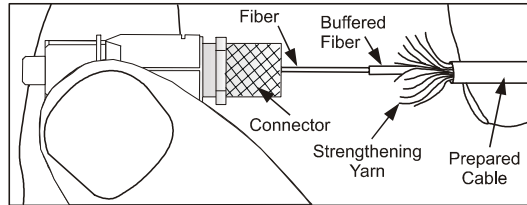

Figure 24. Insert Fiber into Connector (Single-Fiber Cable)

3. **INSTALL CONNECTOR HOLDER** Place the connector in a 1510C Connector Holder. Be careful not to break the fiber.

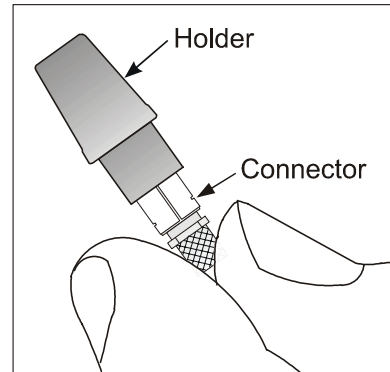

Figure 25. Install Connector Holder

5. **INSTALL CABLE SLEEVE** Slip the cable (crimp) sleeve over the outer jacket and the connector housing to capture the yarn between the housing and sleeve.

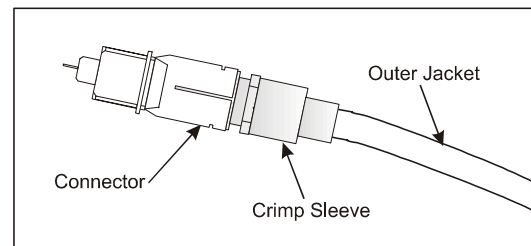

Figure 26. Install Crimp Sleeve (Single-Fiber Cable)

6. **Before crimping, make sure the sleeve is fully seated on the cable retention member.** Align the crimp sleeve with the "SC" cavity of the 1510B Crimping Tool and squeeze the tool handles until they release.

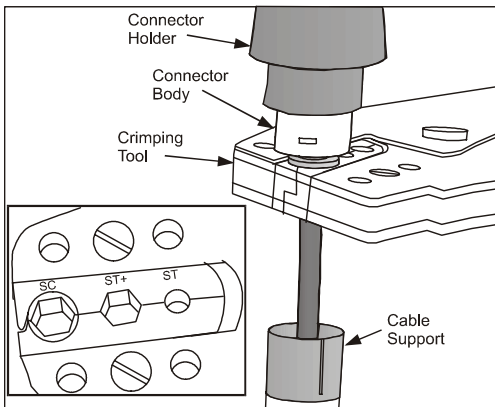

Figure 27. Crimp Cable Sleeve

7. **INSTALL CABLE SUPPORT** Snap the cable support onto the connector to complete the assembly.
8. **ALLOW ADHESIVE TO CURE** Place assembly in a 971A Holder Block. Allow adhesive to cure for at least 1 minute.

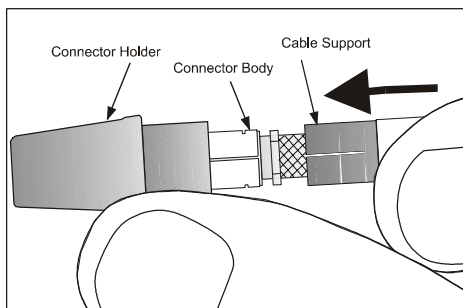

Figure 28. Install Cable Support

6. Cleaving and Polishing

6.1 Cleaving the Fiber

SCORE THE FIBER Remove the 1510C holder from the connector. Carefully wipe any uncured adhesive from around the fiber where it protrudes from the adhesive bead, using the edge of a texwipe. Using one or two strokes with the cleaving tool, score the fiber close to the crest of the adhesive bead.

Note: A clean, short score significantly improves the success rate. **Do not break the fiber.**

Using a **gentle straight pull**, remove the exposed fiber. If the fiber does not pull off with a gentle pull, rescore and try again.

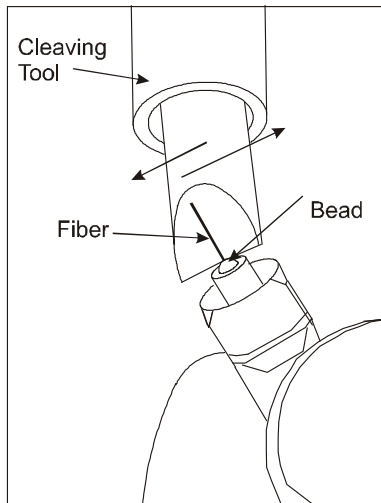

Figure 29. Scoring the Fiber

6.2 Polishing SC Connector Ends

Caution: Contaminants on polishing materials can cause scratches on the end face of the fiber/ferrule. Throughout the entire polishing process, keep work area and all polishing materials clean.

Note 1: Table 2 provides a quick reference for polishing. The Universal Rubber Polishing Pad (300 472 644) must be used to insure acceptable optical performance and end-face geometry.

Step 1. Remove Fiber Stub

- In one hand, hold one sheet of Type G polishing paper (dull side down).
- In the other hand, hold the connector with the tip pointing upward.

Note: When performing the following step, be careful not to break the fiber stub.
- Air polish using light circular motions about 1 inch in diameter to carefully polish off the fiber stub.

Figure 30. Air Polish Connector

Step 2. Remove Excess Adhesive

- Use canned air to clean the back and front of a piece of Type G polishing paper (green).
- Saturate a wipe with isopropyl alcohol (>91% 2-propanol + water).
- Obtain a 5" diameter Universal Polishing Pad (300 472 644) and a 1510A1 Polishing Tool.

640 252 040 02-1111V

In Type G polishing paper (green) with dull side down

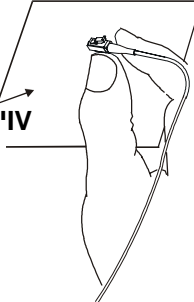

- d. Clean the (unmarked) shiny side of the rubber pad and the polishing tool with the saturated wipe.
- e. Use canned air to blow the rubber pad and polishing tool dry.
- f. Insert the **SC** connector into the 1510A1 polishing tool.

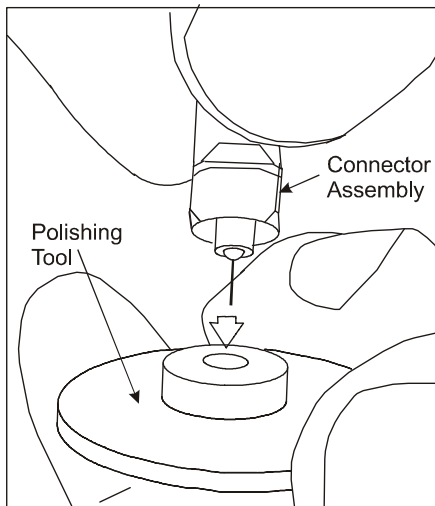

Figure 31. Polishing Tool

- g. Stack four, 3-mil spacers (clear) on the rubber pad.
- h. Place the sheet of Type G polishing paper (green), dull side up, on the spacers.
- i. Gently place the polishing tool and connector onto the polishing paper.

Note: In the following step, you should **not** feel any drag between the fiber and the paper. (If you do, repeat Step 1) Start with light pressure and use figure-8 strokes that are approximately 2 inches high and 1 inch wide. The figure-8 strokes must be well rounded to ensure complete removal of the epoxy from the end of the ferrule.
- i. Using moderate pressure, polish the connector for 30 figure-8 strokes. Move to an unused area of the paper for each connector being polished. Approximately six connectors may be polished on each sheet of Type G paper.

Danger: Optical fibers may emit

Table 2. SC Connector Polishing Overview (Adhesive)

radiation if the far end is connected with a working laser or light-emitting diode (LED). Never view the fiber end of a cable or plug with the naked eye or any optical instrument until absolute

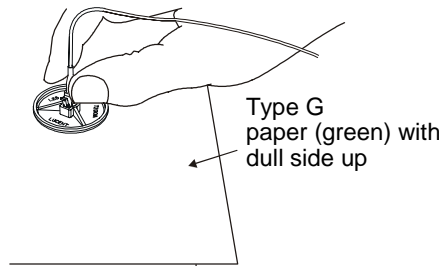

verification is established that the fiber is disconnected from any laser or LED source.

Figure 32. Polishing Connector

- j. Using a 7X magnifier or microscope supplied in the 1032F1 or 1032H Kit, check the tip of the ferrule. No excess adhesive should surround the fiber.

Note: If excess adhesive is found, continue to use Type G polishing paper (green) to remove the excess adhesive. Also, be sure there is no adhesive on the beveled edge of the connector ferrule. Step 2 concludes the polishing procedure for multimode fibers. Step 3 is to be performed for singlemode fibers.

Step 3. Singlemode — Final Polish

- a. Remove the Type G paper and place a sheet of Type M paper (white) over the four spacers (clear), on the rubber pad.

Note: Step 3 is critical for excellent return loss.
- b. Dampen the sheet with distilled water (do not flood). Remove the connector from the polishing tool and use the tool to spread the water over the paper using a few strokes.
- c. Place the connector back into the polishing tool and buff polish the connector using 10 figure-8 strokes, approximately 2 inches high and 1 inch wide, using moderate pressure.
- d. Clean fiber end with a wipe dampened with water, then with a second wipe dampened with alcohol.

Step	Polishing Materials	No. of Figure-8 Strokes	Notes
1 (SM & MM)	Type G (green)	As Required	Air polish to remove fiber stub.
2 (SM & MM)	Type G (green) placed over four spacers (clear) over 5" dia. Rubber Pad (300 472 644)	30, then as required	Dry polish to remove adhesive.
3 (SM Only)	Type M paper (white) placed over four spacers (clear) over 5" dia. Rubber Pad (300 472 644)	10	Wet polish. Wet paper with distilled water.
Repair polish, only if needed	Type F (yellow) placed over four spacers (clear) over 5" dia. Rubber Pad (300 472 644)	5 strokes, then as required to remove flaw (10 strokes max.)	Dry polish. For singlemode fibers, after flaw is removed, repeat Step 3

7. Inspection

7.1 Using Microscope to Inspect Fiber

1. ATTACH CONNECTOR TO MICROSCOPE

See **Precautions** on **page 2**. Insert the connector tip into the bottom of the microscope. Open the microscope barrels to illuminate the connector tip, and use the side wheel to focus. A high-intensity light may be used at the other end of the fiber to illuminate the core area.

Caution: Do not use a laser or LED to illuminate the core area for viewing.

The core may not necessarily illuminate if an adhesive film or bead still exists on the connector end face.

- INSPECT FIBER END** An acceptable fiber end is free of cracks. Voids or scratches must be avoided in the core area. If the fiber is unacceptable, this fiber end must be reterminated.
- If the connector is not to be used immediately, cover the end with the protective cap.

7.2 Repairs

- Place a sheet of Type F paper (yellow) over four spacers (clear) over the Universal Rubber Polishing Pad (300 472 644).
- Using firm pressure, polish the connector 5 strokes or until the flaw has been removed; however, do not exceed 10 strokes to avoid over polishing the connector. This concludes the repair procedure for multimode connectors. Repeat Step 3 in Section 6.2 for singlemode connectors.

Note: Type F paper (5 sheets) is available as comcode 108601469

7.3 Snap On Connector Grip

Snap the connector grip onto the polished assembly and cover the end of the connector with the protective cap. This completes the procedure.

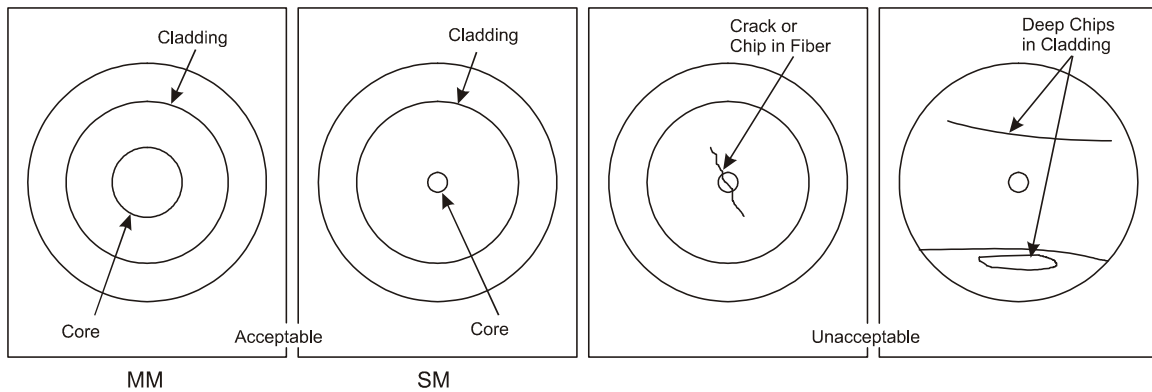

Figure 33. Fiber End Views (Microscope)

8. Interconnecting with SC Fiber Optic Connectors

Several interconnecting couplings are available for joining the SC Fiber Optic Connectors. See Ordering Information in this manual.

8.1 Cleaning Connector and Coupling

- CLEAN END OF CONNECTOR TIP** Clean the end and sides of the connector ferrule with a wipe dampened with isopropyl alcohol.

Important: If the connector tip is not thoroughly cleaned, the signal performance will be affected.

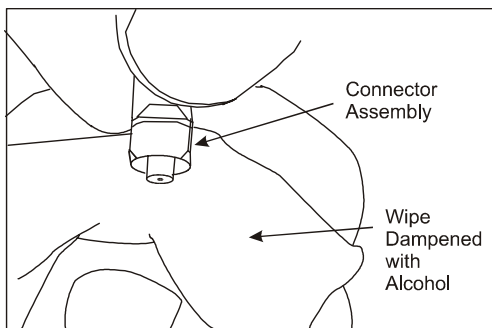

Figure 34. Cleaning Connector Tip

- CLEAN INTERIOR OF COUPLING** Use pipe cleaners saturated with isopropyl alcohol to remove debris from the interior of the coupling. *This should be done only if necessary.*

Using canned air, remove any dust particles from the interior of the coupling.

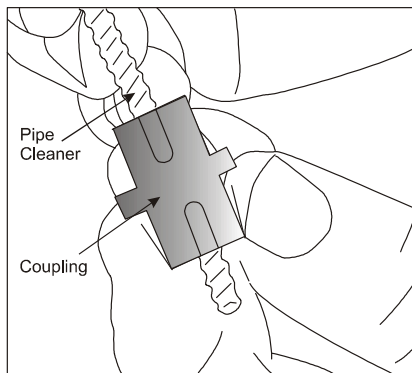

Figure 35. Cleaning Coupling

8.2 Installing Coupling on SC Connectors

- INSTALL COUPLING** Install the SC connectors onto the coupling by aligning the key on connector grip with the slot in the coupling. Complete the connection by pushing the connectors into the coupling.

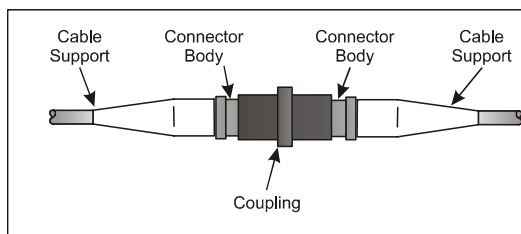

Figure 36. SC Connectors Coupled

- If a high-loss condition exists, use canned air to reclean the interior of the coupling, and reinstall the coupling as just described.
- When doing rearrangements or reinsertions of an SC connector, blow any dust from the coupling using canned air. Clean the connector tip with a wipe dampened with isopropyl alcohol and push the connector onto the coupling.

**640-252-049-02-UNIV
Instruction Sheet**

9. Ordering Information

9.1 Tool Kits

1032F1 Tool Kit (Comcode 107 149 320) – Contains tools for installing SC and ST connectors onto 0.9-mm buffered fibers and 1.6 and 3.0-mm cordages

Kit Quantity	Description	Replacement Comcode	Replacement Quantity
1	1510B Crimping Tool	106 918 998	1 Tool
1	300B Microscope	104 412 077	1 Microscope
1	1510A1 Polishing Tool	108 237 710	1 Tool
12	600B Connector Holders	107 118 549	12 Holders
1	700A Stripping Tool	104 278 478	1 Tool
1	1026A Heat-Strip Tool	105 514 764	1 Tool
2	971A Holder Blocks	104 229 398	1 Holder
1	975A Cleaving Tool	103 808 770	1 Tool
1	Scissors	105 257 364	2 Scissors
1	6-inch Scale	105 257 356	5 Scales
1	Isopropyl Alcohol Bottle	105 257 463	2 Bottles
1	Glass Plate	105 075 618	2 Plates
1	Sheath Removal Tool (R-4366)	105 114 581	1 Tool
1	Instruction Manual	Contact OFS Rep.	1 Manual
15	Micro Clips (1043A)	106 228 455	15 Micro Clips
1	200A Curing Oven	104 055 058	1 Oven
12	SC Curing Fixture	106 919 004	12 Fixtures
2	Modified SM/MM SC Grips	107 480 022	10 Grips
1	Instruction Sheet (ST [®] II+ EZ)	Contact OFS Rep.	1 Copy
1	Instruction Sheet (SC EZ)	Contact OFS Rep.	1 Copy
1	Rubber Polishing Pad	106 978 992	1 Pad
1	1039B Cut-Length Template	107 149 783	5 Templates
1	Eye Loupe or Magnifier	N/A	

1032H Tool Kit (Comcode 107 149 320) – Contains tools for installing BTW LC, SC, and ST Connectors onto 9.0-mm buffered fibers

Kit Quantity	Description	Replacement	
		Comcode	Quantity
1	ST/SC Microscope Adapter	106 979 008	1 Adapter
2	1510A1 Polishing Tool	108 237 710	1 Tool
12	600B Connector Holders	107 118 549	12 Holders
1	5B5 Strip Tool	105 257 414	1 Tool
1	975A Cleaving Tool	103 808 770	1 Tool
1	Scissors	105 257 364	2 Pairs

1	Glass Plate	105 075 618	2	Plates
1	Stripping Tool (R-4366)	105 114 581	1	Tool
15	Micro Clips (1043A)	106 228 455	15	Clips
12	SC Curing Fixtures	106 919 004	12	Fixtures
1	Rubber Polishing Pad (Square)	106 978 992	1	Pad
1	1039B Template (SC/ST)	107 149 783	5	Templates
1	Magnifier	NA		
12	LC Connector Holder	107 852 493	12	Holders
2	LC Polishing Tool (T2001A)	108 209 651	1	Tool
1	LC Template	108 262 536	1	Template
1	LC Microscope	107 863 946	1	Microscope

Universal Rubber Polishing Pad (Comcode 300 472 644) -- one 5" diameter rubber polishing pad for polishing pre-radiused LC, SC, and ST connectors

9.2 Consumables

Universal Polishing Kit (300 472 651) -- Contains enough supplies to field polish 100 SM or MM connectors.

Kit Quantity	Description	
1 Package	Wipes	
15 Syringes	Syringes	
25 Tips	Dispensing Tips	
20 Sheets	Type G Polishing Paper (green)	6 by 6 inches (152 by 152 mm)
10 Sheets	Type M Polishing Paper (white)	5" dia. disc (127 mm dia.)
5 Sheets	3-mil Mylar Spacer (clear)	6 by 6 inches (152 by 152 mm)

Universal Polishing Kit for Multimode Only (300 486 552) -- Contains enough supplies to field polish 100 MM connectors.

Kit Quantity	Description	
1 Package	Wipes	
15 Syringes	Syringes	
25 Tips	Dispensing Tips	
20 Sheets	Type G Polishing Paper (green)	6 by 6 inches (150 by 150 mm)
5 Sheets	3-mil Mylar Spacer (clear)	6 by 6 inches (152 by 152 mm)

Type G Paper (Comcode 300 472 669) -- Contains 20, 6"x6" sheets of (green) Type G Polishing Paper

Type M Paper (Comcode 300 472 677) -- Contains 10, 5" diameter sheets of (white) Type M Polishing Paper

**640-252-049-02-UNIV
Instruction Sheet**

EZ Adhesive (Comcode 106 730 856) – One bottle of anaerobic adhesive.

EZ Primer (Comcode 106 730 849) – One bottle of primer.

D-181755 Kit (Comcode 105 052 047) – Contains the parts required to make a transition from ribbon or LIGHTPACK® bundle to individually buffered fibers.

9.3 SC Connectors

Connector Code	Comcode	Fiber Mode	Ferrule (Zirconia)	Description Housing	Cable Size (mm)	Fiber OD (µm)	Packaging
P6000A-Z-125	106 917 438	SM	Domed	Plastic	1.6, 3.0	125	Individual
P6000A-Z-125-100	107 503 856	SM	Domed	Plastic	0.9	125	Bulk
P6001A-Z-125	106 917 586	SM	Domed	Plastic	0.9	125	Individual
P6001A-Z-125-100	107 503 864	SM	Domed	Plastic	0.9	125	Bulk
P6200A-Z-125	106 917 776	MM	Domed	Plastic	1.6, 3.0	125	Individual
P6200A-Z-125-100	107 503 872	MM	Domed	Plastic	0.9	125	Bulk
P6201A-Z-125	106 917 800	MM	Domed	Plastic	0.9	125	Individual
P6201A-Z-125-100	107 503 880	MM	Domed	Plastic	0.9	125	Bulk

9.4 Couplings (Standard)

Coupling Code	Comcode	Fiber Type	Coupling Type	Color	Description
C6000A-4	106 703 200	MM/SM	Simplex	Blue	Snap-in coupling
C6000A-5	107 022 980	MM/SM	Simplex	Blue	Snap-in coupling
C6060A-4	106 817 380	MM/SM	Duplex	Blue	Snap-in coupling
C6061A-4	107 118 903	MM	Duplex	Beige	Snap-in coupling
C6070A-4	107 087 967	MM	Duplex	Beige	Snap-in coupling
2A1	106 917 263	NA	Duplex	Black	Quantity of five Duplex Connector Clips
2A1-100	108 136 516	NA	Duplex	Black	Bulk Duplex Connector Clips

10. Assistance Information

For more **information**, contact an OFS Sales Representative.

For fiber optic **technical assistance**, call **1-888-FIBER HELP**.