

**EPOXY INSTALLATION FOR SC  
FIBER OPTIC CONNECTORS  
(MULTIMODE AND SINGLEMODE)  
USING UNIVERSAL POLISHING PROCEDURE**

**640-252-049-03-UNIV  
Comcode D05AK0031  
Issue 2  
July 2005**

# Table of Contents

1.0	General .....	1
2.0	Precautions .....	2
3.0	Cable and Fiber Preparation.....	2
3.1	Coated Fiber.....	2
3.2	Buffered Fiber Cable (Premises/Building).....	3
3.3	Jacketed Fiber Cable (1.6-mm and 3.0-mm) .....	4
4.0	Epoxy Preparation.....	6
4.1	Preparation of Epoxy Furnished in Plastic Container .....	6
5.0	Connector Installation .....	6
5.1	Connector – Buffered Fiber Assembly .....	6
5.2	Connector – Jacketed-Fiber Cable Assembly (1.6-mm and 3.0 mm).....	7
6.0	Curing Epoxy, Cleaving and Polishing .....	9
6.1	Curing Epoxy .....	9
6.2	Cleaving the Fiber .....	9
6.3	Polishing SC Connector Ends.....	10
7.0	Inspection.....	12
7.1	Using Microscope to Inspect Fiber .....	12
7.2	Repairs .....	12
7.3	Snap On Connector Grip.....	12
8.0	Interconnecting with SC Fiber Optic Connectors .....	13
8.1	Cleaning Connector and Coupling .....	13
8.2	Installing Coupling on SC Connectors.....	13
9.0	Ordering Information.....	14
9.1	Tool Kits .....	14
9.2	Consumables (D-Kits).....	15
9.3	SC Connectors.....	16
9.4	Couplings (Standard) .....	16
10.	Assistance Information .....	16

# EPOXY INSTALLATION FOR SC FIBER OPTIC CONNECTORS (MULTIMODE AND SINGLEMODE) USING UNIVERSAL POLISHING PROCEDURE

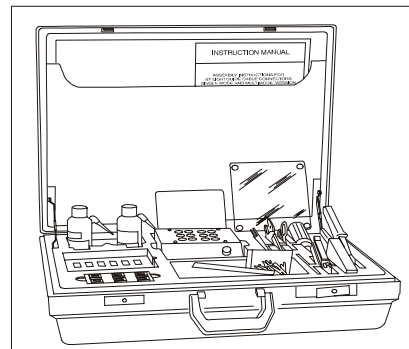
## 1.0 General

The 1032B5 (standard version) and the 1032B6 (international version) Tool Kits contain tools to assemble SC Connectors onto fiber optic cables. The 1032B5 Kit is identical to the 1032B6 Kit except the 200A1 Curing Oven replaces the 200A Curing Oven in the 1032B6 international version.

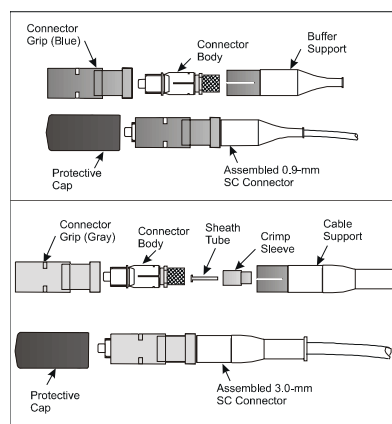
The Universal Polishing Kit contains polishing paper and other materials required to assemble approximately 100 connectors. (Note: Epoxy is not included in the Universal Polishing Kit) See the table below for proper applications.

The assembled SC Fiber Optic Connector is intended for use in Local Area Networks (LANs), Premises Distribution Systems (PDSs), fiber to the home, and other applications where quality, small-size, low-loss, and low-cost connections are required.

Ordering Information for the 1032( ) Tool Kits and the SC Connector assembly kits is provided in **Section 9**.



**Figure 1. 1032B(5/6) Tool Kit**



**Figure 2. SC Fiber Optic Connectors**

**Table 1. Connector Product Description**

Connector Code	Type Mode	Buffer or Jacket Size (mm)	End Face Geometry	Univ. Consumable Kit	Tool Kit Required 1032( )
<b>P6200A-Z-125</b>	MM	1.6, 3.0	Domed	300486552	B5 or B6
<b>P6201A-Z-125</b>	MM	0.9	Domed	300486552	B5 or B6
<b>P6000A-Z-125</b>	SM	0.9, 1.6, 3.0	Domed	300472651	B5 or B6
<b>P6001A-Z-125</b>	SM	0.9	Domed	300472651	B5 or B6
<p><b>Note 1:</b> When using 250-<math>\mu</math>m coated fiber, also use D-181755 Consumable Kit (see Section 3.1). The D-182919 Consumable Kit is required for 1.6-mm MiniCord™ termination.</p> <p><b>Note 2: Jacketed Fiber Cable (Cordage) Compatibility:</b> The SC connector should only be installed onto 1.6mm MiniCord™ or 3.0 mm 9000 Series cordage containing stiff nylon buffered fibers. The SC connector will not function properly when installed onto cordages with soft PVC buffered fibers.</p>					

## 2.0 Precautions

- Safety glasses should be worn at all times while performing the installation procedures.
- Avoid skin contact with epoxy adhesive.
- When the heater is in operation, place it away from combustibles.
- Disconnected optical connectors may emit radiation if the far end is coupled with a working laser or Light-Emitting Diode (LED). Do not view the fiber end of a cable or plug with an optical instrument until absolute verification is established that the fiber is disconnected from any laser or LED source.
- For cleaning of these fiber optic products, always use Isopropyl Alcohol (>91% 2-Propanol + water).
- It is recommended that you use the E-Series Ultrajet<sup>®</sup> from Chemtronics<sup>®</sup>, Inc. when canned air is required.

## 3.0 Cable and Fiber Preparation

### 3.1 Coated Fiber

**Note 1:** Use the appropriate procedures for preparing outside plant (OSP) cable. See 636-299-110 for more information on grounding, blocking, and buffering Fiber Optic Cable.

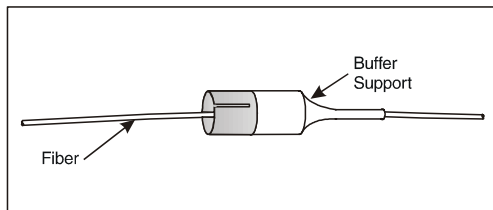
**Note 2:** Before starting cable and fiber preparation, the curing oven may be set up to save warm-up time later. See **Section 6 - Curing Epoxy** section for detailed instructions.

**Important:** Do not attempt to remove the fiber coating until a buffer tube has been placed over the coated fiber. This is to prevent cutting the fiber by mistake.

1. **EXPOSE AN APPROPRIATE LENGTH OF COATED FIBER** (as specified in the

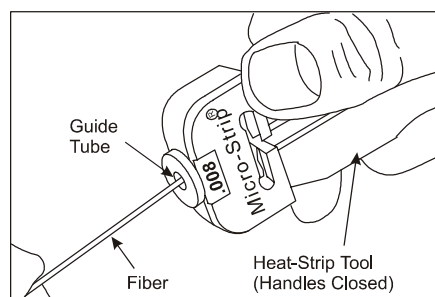
D-181755 Kit) to allow for connector installation and termination.

2. **PLACE AN APPROPRIATE LENGTH OF BUFFERED TUBING** from the D-181755 Kit over the fiber to be stripped.
3. **PLACE BUFFER SUPPORT ONTO FIBER** Slip the buffer support onto the buffer tube covering the fiber (Figure 3).

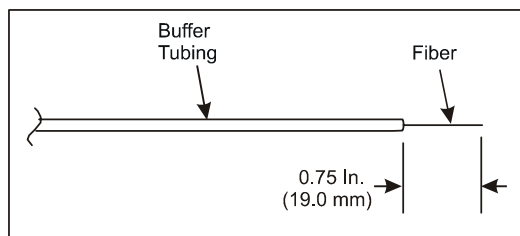


**Figure 3. Install Buffer Support on Buffer Tubing**

4. **REMOVE FIBER COATING** With the stripper handles open and the buffered tube aligned with the end of the fiber, insert both fiber and buffered tubing through the guide tube opening enough to allow about 0.75 inch (19 mm) of buffer and fiber coating to be removed (Figures 4 and 5).
5. Close the handles and pull the buffer away from the tool with a smooth motion.
6. Wipe the stripped fiber with a wipe dampened with isopropyl alcohol to remove any residual coating.



**Figure 4. Heat-Strip Tool - Removing Fiber Coating from Buffered Fiber**



\* Chemtronics and Ultrajet are registered trademarks of Chemtronics, Inc.

**Figure 5. Recommended Strip Dimensions for Singlemode and Multimode Connectors**

- INSTALL CONNECTOR ON FIBER**  
Use the procedures outlined in **Connector Installation, Section 5.1**, in this manual to complete installation of the connector, cure the epoxy, polish and inspect the fiber end.

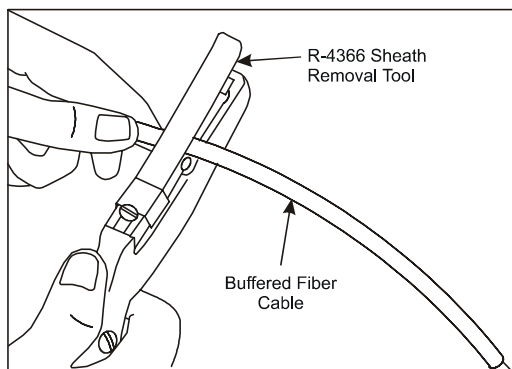
### 3.2 Buffered Fiber Cable (Premises/Building)

- REMOVE OUTER JACKET** Ring-cut the outer sheath the required distance from the cable end with the R-4366 sheath-removal tool. **IMPORTANT: Do not cut into the fibers.** Typical length is approximately 24 to 36 inches (0.61 to 0.91 meters).

**Note 1:** The exposed buffered fiber should be long enough to:

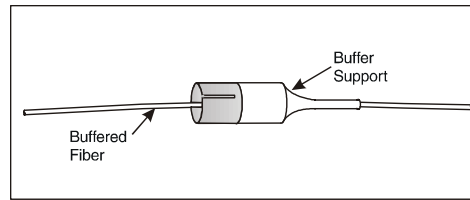
- Allow for placement into the equipment cabinet
- Allow access to the curing oven, polishing plate, etc.
- Prevent stress on the fiber during the application of the connector.

**Note 2:** See Table 1, page 1, to verify correct connector choice for cable type.



**Figure 6. R-4366 Sheath Removal Tool - Ring-Cut Cable Jacket**

- PLACE BUFFER SUPPORT ONTO CABLE** Slip the buffer cap and the buffer support onto the buffered fiber.

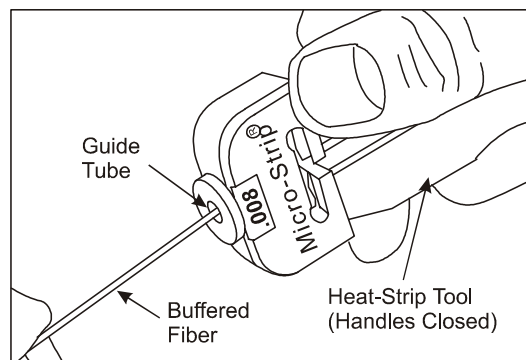


**Figure 7. Install Buffer Support on Buffered Fiber**

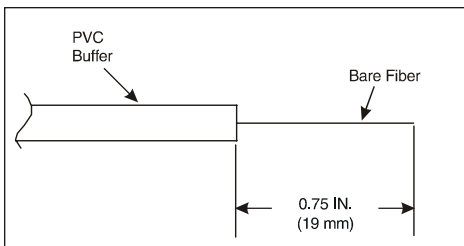
- MEASURE AND MARK THE BUFFERED FIBER 0.75 inch (19 mm) from the end.**

#### 4. REMOVING BUFFER AND FIBER COATING

- Refer to 1026A Heat-Strip Tool Operating Instructions for setup. Make sure heater unit is fully inserted.
- Insert buffered fiber through the guide tube to allow 0.75 inch (19 mm) of the buffer and coating to be removed.
- Close the handles and wait 6 to 10 seconds for softening of the buffer to occur. Pull the fiber from the tool with one smooth motion.
- Wipe the stripped fiber once with a wipe dampened with isopropyl alcohol to remove any residual coating.

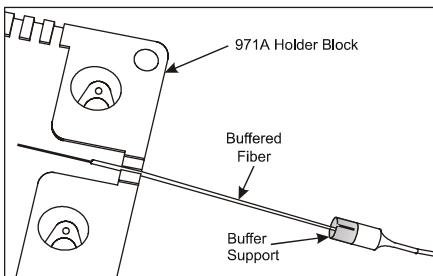


**Figure 8. Heat-Strip Tool - Removing Fiber Coating from Buffered Fiber**



**Figure 9. Buffered Fiber Stripping Dimensions**

5. **SET ASIDE THE PREPARED FIBERS**  
Place the prepared fiber into the grooves of the 971A holder block (provided with the tool kits).



**Figure 10. 971A Holder Block with Buffered Fiber**

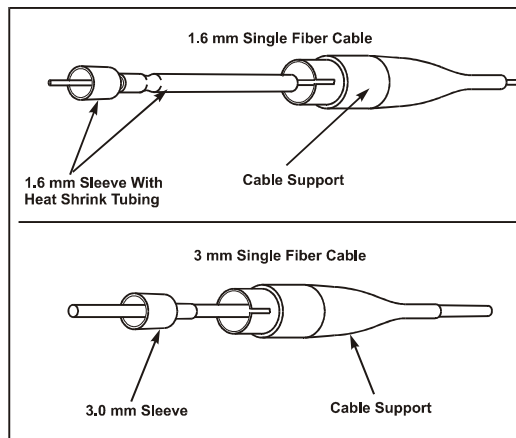
6. **INSTALL CONNECTOR ON FIBER**  
Use the procedures outlined in Connector Installation, Section 5.1, to complete the installation of the connectors, cure the epoxy, polish and inspect the fiber end.

### 3.3 Jacketed Fiber Cable (1.6-mm and 3.0-mm)

(See Table 1, Note 2 on page 1 before proceeding)

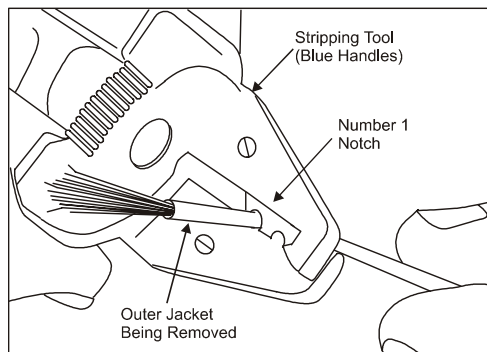
1. **PLACE CABLE SUPPORT AND CRIMP SLEEVE ONTO CABLE** Slip the cable support and the crimp sleeve onto the cable.

**Note:** If terminating 1.6-mm MiniCord™ cable, use the crimp sleeve provided in the D-182919 Kit.



**Figure 11. Cable Support and Sleeve on Single Fiber Cable**

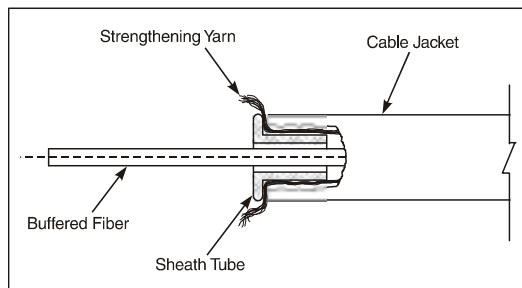
2. **MEASURE AND MARK CABLE** Using either a scale or template, measure and mark the cable 1.35 inches (34.3 mm) from the end of the cable.
3. **REMOVE OUTER JACKET** Using the Number 1 notch on the blue-handled 700A stripping tool, remove the outer jacket back to the mark.



**Figure 12. Stripping Outer Jacket of Single Fiber Cable**

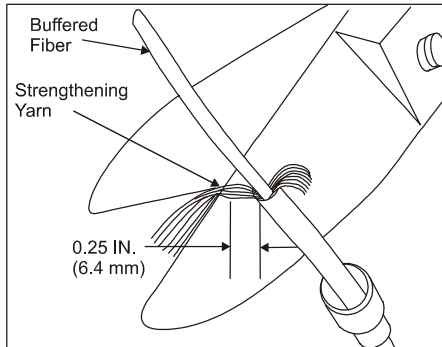
4. **INSERT SHEATH TUBE INTO CABLE JACKET**

- For 3.0-mm cable, insert the sheath tube over the buffered fiber and into the cable jacket.



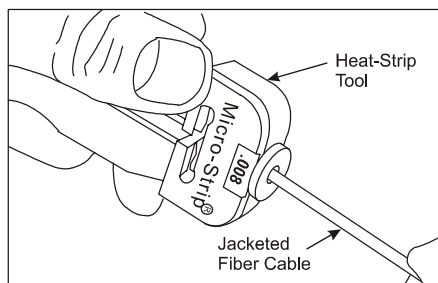
**Figure 13. Sheath Tube Insertion 3.0 mm**

5. **CUT STRENGTHENING YARN** With the strengthening yarn separated into two equal size bundles, use scissors to trim strands 0.25 inch (6.4 mm) from edge of outer jacket. Flare yarn evenly all around the cable.



**Figure 14. Cutting Strengthening Yarn - Single Fiber Cable**

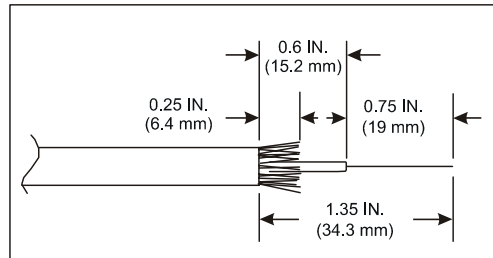
6. **MEASURE AND MARK BUFFERED FIBER** Measure and mark the buffered fiber 0.75 inch (19 mm) from the end of the buffered fiber.
7. **REMOVING BUFFER AND FIBER COATING**
  - Refer to 1026A Heat-Strip Tool Operating Instructions for setup. Make sure heater unit is fully inserted.
  - Insert buffered fiber through the guide tube to allow 0.75 inch (19 mm) of the buffer and coating to be removed.
  - Close handles and wait 6 to 10 seconds for softening of buffer to occur. Pull fiber from tool with one smooth motion.
  - Wipe stripped fiber once with a wipe dampened with isopropyl alcohol to remove any residual coating.



**Figure 15. Heat-Strip Tool - Removing Buffer and Fiber Coating**

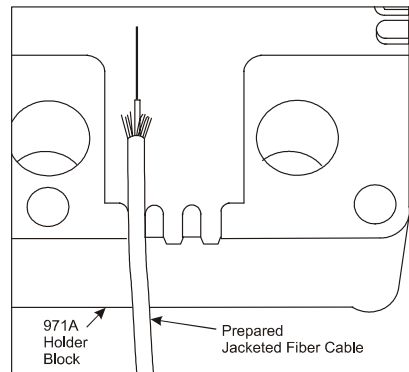
**RECOMMENDED DIMENSIONS FOR 1.6-mm MiniCord™ AND 9000 SERIES CORDAGE**

The recommended dimensions for the prepared cable and fiber are shown in Figure 17.



**Figure 16. Recommended Dimensions for MiniCord™ and 9000 Series Cordage**

8. **SET ASIDE PREPARED CABLE** Place the prepared cable into the grooves of the 971A holder block provided with the tool kit.
9. **INSTALL CONNECTOR ON FIBER** Use the procedures outlined in Connector Installation, Section 5.2, to complete installation of the connector, cure the epoxy, polish and inspect the fiber end.



**Figure 17. 971A Holder Block with Jacketed Fiber Cable**

### 4.0 Epoxy Preparation

The epoxy package is furnished with the consumable kit. See the ordering information in the back of this manual.

#### 4.1 Preparation of Epoxy Furnished in Plastic Container

1. **REMOVE EPOXY DIVIDER** This is a two-part epoxy separated with a divider. The divider must be removed to allow the epoxy to be mixed.
2. **MIX THE EPOXY** Using the divider, thoroughly mix the epoxy until both parts are blended into a smooth, uniform color.

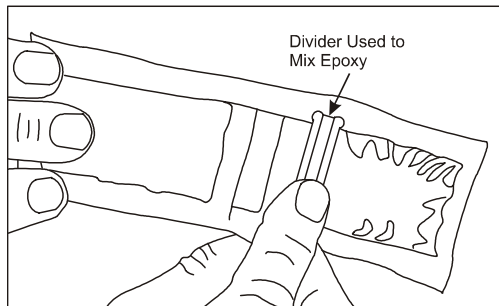


Figure 18. Mix the Epoxy

3. **INSTALL SYRINGE TIP** Place the syringe tip onto the syringe and twist to lock it in place. Then remove the plunger to allow the mixed epoxy to be loaded into the syringe.
4. **PLACE EPOXY INTO SYRINGE** Fold the epoxy package in half, cut the corner of the package, and squeeze the mixed epoxy into the syringe. Replace the plunger in the syringe. A 3/4-inch length (19 mm) of epoxy will be enough for about 12 connectors.

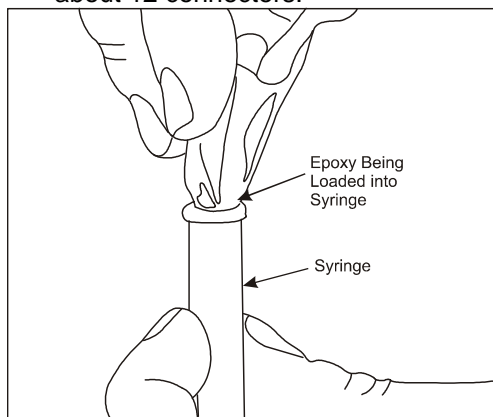


Figure 19. Place Epoxy into Syringe

5. **REMOVE AIR FROM SYRINGE** Remove air pockets from the syringe by holding the syringe tip upward and ejecting epoxy until the air pockets are removed.

### 5.0 Connector Installation

#### 5.1 Connector – Buffered Fiber Assembly

1. **PLACE CONNECTOR IN THE 1510C CONNECTOR HOLDER** Hold the connector towards a light and check to make sure the hole in the connector tip is clear of foreign matter. Use music wire (furnished) to clear the hole if necessary. Place the connector into the 1510 Connector Holder.

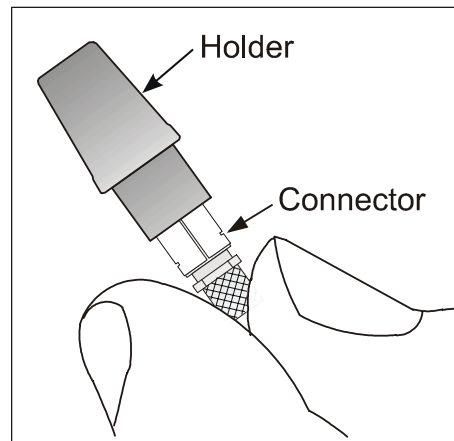


Figure 20. Install Connector Holder

2. **INJECT EPOXY INTO THE CONNECTOR TIP**
  - Insert the tip of the syringe through the tubing in the back of the connector until it bottoms.
  - Slowly inject epoxy into the connector until a small bead appears on the connector tip.
  - When the epoxy forms a small bead on the tip, maintain pressure on the plunger and slowly withdraw the syringe. **(Note: Do not fill the plastic tubing with adhesive. Do not allow the adhesive to get onto the connector housing components.)**



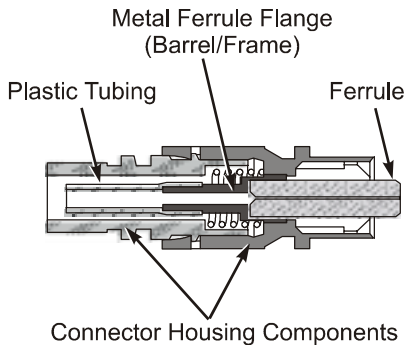


Figure 21. SC Connector Components

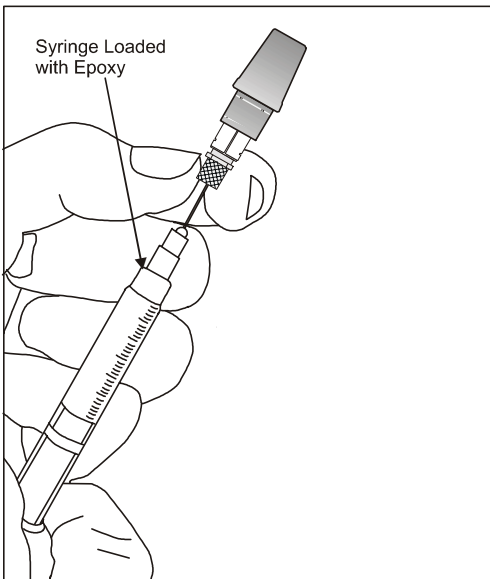


Figure 22. Inject Epoxy into Domed Singlemode or Multimode Connector Tip

3. **APPLY EPOXY TO FIBER AND BUFFER** Using the syringe, apply a **thin** coating of epoxy to the fiber and 0.1 inch (2.5 mm) of the buffer.

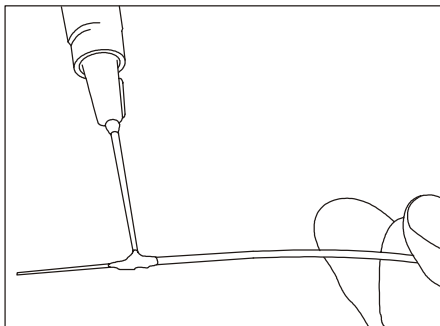


Figure 23. Apply Epoxy to Fiber and Buffer

4. **INSERT FIBER INTO CONNECTOR**  
Insert the fiber through the connector, carefully feeling for the opening in the

tip. When the fiber is seated, pull it back slightly and watch for movement at the tip to make sure the fiber has not been broken. Reseat the fiber into the connector making sure the buffer is completely seated against the ceramic.

5. **INSTALL BUFFER SUPPORT** Slide the buffer support onto the back of the connector.

**Important: Use only the connector holder or buffer support when handling the connector assembly. Make sure that the buffered fiber is fully inserted into the connector. Place a micro clip on the buffer support as shown. This inhibits the buffered fiber from being accidentally pulled out of the connector.**

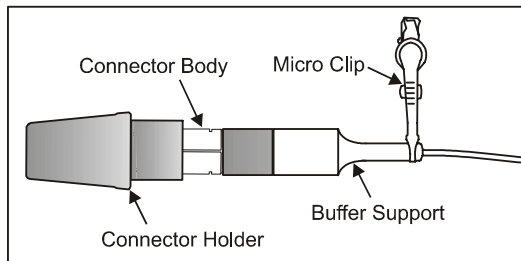
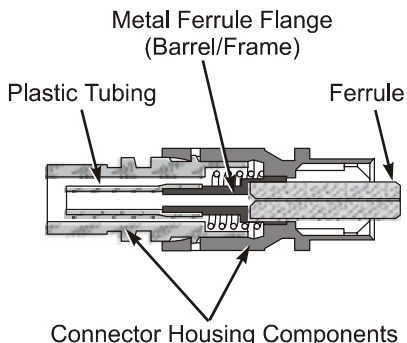


Figure 24. Install Buffer Support and Micro Clip

## 5.2 Connector – Jacketed-Fiber Cable Assembly (1.6-mm and 3.0 mm)

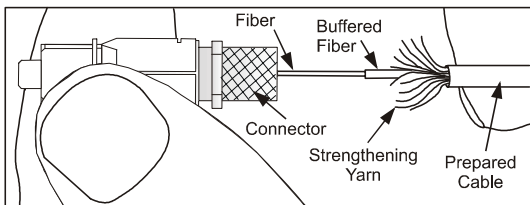
1. **PLACE CONNECTOR IN 1510C CONNECTOR HOLDER** Hold the connector towards a light and check to make sure the hole in the connector tip is clear of foreign matter. Use music wire (furnished) to clear the hole if necessary.
2. **INJECT EPOXY INTO THE CONNECTOR TIP**
  - Insert the tip of the syringe through the tubing in the back of the connector until it bottoms.
  - Slowly inject epoxy into the connector until a small bead appears on the connector tip.
  - When the epoxy forms a small bead on the tip, maintain pressure on the plunger and slowly withdraw the syringe. **(Note: Do not fill the plastic**

tubing with adhesive. Do not allow the adhesive to get onto the connector housing components.)



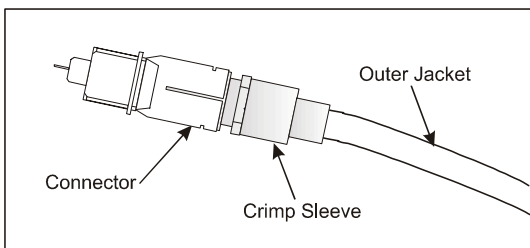
**Figure 25. SC Connector Components**

3. **APPLY EPOXY TO FIBER AND BUFFER** Using the syringe, apply a **thin** coating of epoxy to the fiber and 0.1 inch (2.5 mm) of the buffer.
4. **INSERT FIBER INTO CONNECTOR** Insert the fiber into the connector. Rotate the connector carefully feeling for the opening in the tip. When the fiber is seated, pull it back slightly and watch for movement at the tip to make sure the fiber has not been broken. **Reseat the fiber into the connector so the outer jacket butts against the connector barrel.**



**Figure 26. Insert Fiber into Connector (Single-Fiber Cable)**

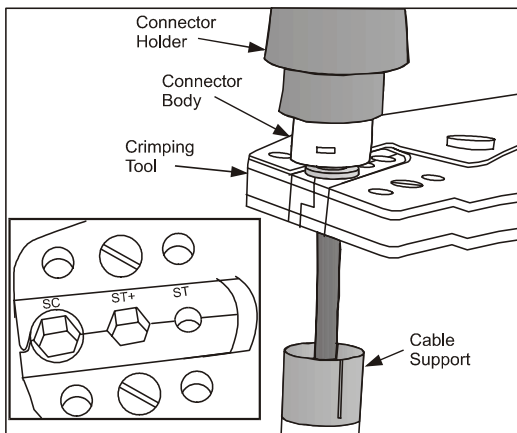
5. **INSTALL CRIMP SLEEVE** Slip the crimp sleeve over the outer jacket and trap the strengthening yarn between the connector housing and the sleeve.



**Figure 27. Install Crimp Sleeve (Single-Fiber Cable)**

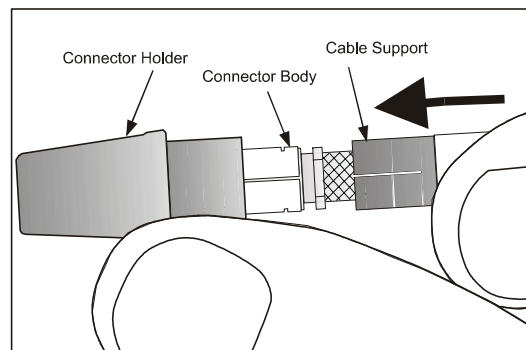
6. **Before crimping, make sure the sleeve is fully seated on the cable retention member.** Align the crimp sleeve with the “SC” cavity of the 1510B Crimping Tool and squeeze the tool handles until they release.

For 1.6-mm MiniCord™ cable, use the crimp sleeve provided in the D-182919 Kit. Align the crimp sleeve with the “SC” cavity of the 1510B Crimping Tool and squeeze the crimping tool handles until they release.



**Figure 28. Crimp Cable Sleeve (Single-Fiber Cable)**

7. **INSTALL CABLE SUPPORT** Snap the cable support onto the connector to complete the pre-curing assembly. The assembly is now ready to be placed into the curing oven.



**Figure 29. Install Cable Support (Single-Fiber Cable)**

## 6.0 Curing Epoxy, Cleaving and Polishing

### 6.1 Curing Epoxy

1. **SET UP THE CURING OVEN** Place the oven away from combustibles, and connect the power cord to a power source (**120 V 60 Hz AC for the 200A oven and 220 V 50 Hz AC for the 200A1 international oven**). To apply power, push the ON/OFF switch to the ON position. The switch will illuminate, indicating that the power is on. In about 5 minutes, an illuminated READY lamp indicates that the oven is ready for use. (**Note: If terminating 1.6mm MiniCord cable, place the Heat Tube Assembly Fixtures into the ports of the oven.**)

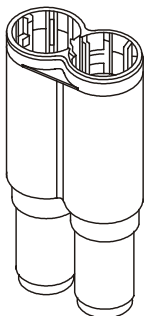


Figure 30. Heat Tube Assembly Fixtures

2. **PLACE CONNECTOR INTO OVEN** Place the connector and holder assembly into one of the oven ports. Cure for 10 minutes. Connectors with 1.6mm MiniCord cable will be inserted into the Heat Tube Assembly Fixtures.

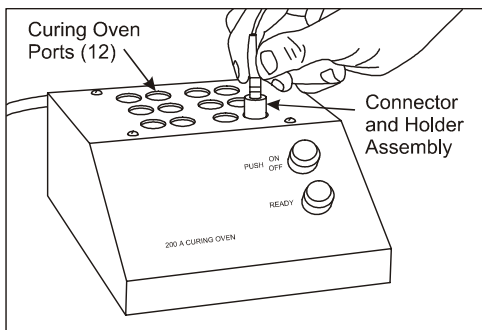


Figure 31. Place Connector into Oven

3. **PLACE CONNECTOR INTO 971A HOLDER BLOCK** After 10 minutes of curing time, remove the assembly from the oven and place it into one of the ports in the 971A holder block to cool. Remove micro clip from buffer support after connector has cooled.

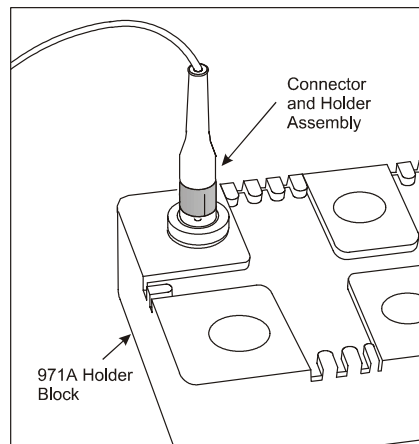


Figure 32. Place Connector into 971A Holder Block

### 6.2 Cleaving the Fiber

**SCORE THE FIBER** Remove the 1510C holder from the connector. Using one or two strokes with the cleaving tool, score the fiber close to the crest of the epoxy bead.

**Note:** A clean, short score significantly improves the success rate. **Do not break the fiber.**

Using a **gentle straight pull**, remove the exposed fiber. If the fiber does not pull off with a gentle pull, rescore and try again.

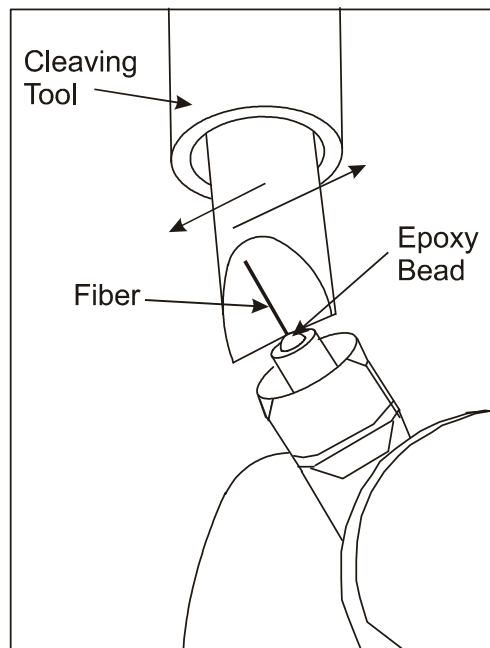


Figure 33. Scoring the Fiber

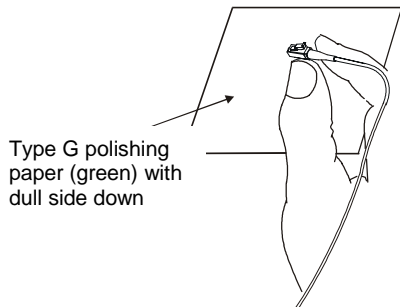
### 6.3 Polishing SC Connector Ends

**Caution:** Contaminants on polishing materials can cause scratches on the end face of the fiber/ferrule. Throughout the entire polishing process, keep work area and all polishing materials clean.

**Note 1:** Table 2 provides a quick reference for polishing. The Universal Rubber Polishing Pad (300 472 644) must be used to insure acceptable optical performance and end-face geometry.

#### Step 1. Remove Fiber Stub

- a. In one hand, hold one sheet of Type G polishing paper (dull side down).
  - b. In the other hand, hold the connector with the tip pointing upward.
- Note:** When performing the following step, be careful not to break the fiber stub.
- c. Air polish using light circular motions about 1 inch in diameter to carefully polish off the fiber stub.

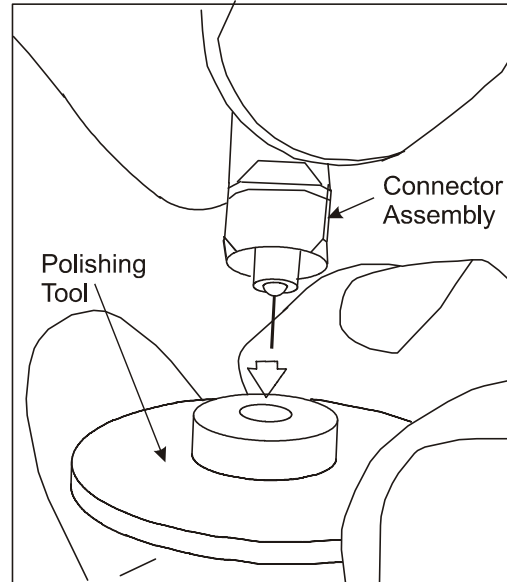


**Figure 34. Air Polish Connector**

#### Step 2. Remove Excess Epoxy

- a. Use canned air to clean the back and front of a piece of Type G polishing paper (green).
- b. Saturate a wipe with isopropyl alcohol (>91% 2-propanol + water).
- c. Obtain a 5" diameter Universal Polishing Pad (300 472 644) and a 1510A1 Polishing Tool.
- d. Clean the (unmarked) shiny side of the rubber pad and the polishing tool with the saturated wipe.

- e. Use canned air to blow the rubber pad and polishing tool dry.
- f. Insert the **SC** connector into the 1510A1 polishing tool.

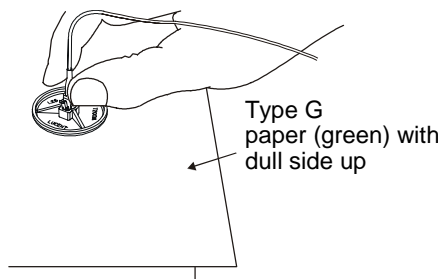


**Figure 35. Polishing Tool**

- g. Stack four, 3-mil mylar spacers (clear) on the rubber pad.
  - h. Place a sheet of Type G polishing paper (green), dull side up, on the spacers.
  - i. Gently place the polishing tool and connector onto the polishing paper.
- Note:** In the following step, you should **not** feel any drag between the fiber and the paper. (If you do, repeat Step 1) Start with light pressure and use figure-8 strokes that are approximately 2 inches high and 1 inch wide. The figure-8 strokes must be well rounded to ensure complete removal of the epoxy from the end of the ferrule.

- i. Using moderate pressure, polish the connector for 45 figure-8 strokes. Move to an unused area of the paper for each connector being polished. Approximately six connectors may be polished on each sheet of Type G paper.

**Danger:** Optical fibers may emit radiation if the far end is connected with a working laser or light-emitting diode (LED). Never view the fiber end of a cable or plug with the naked eye or any optical instrument until absolute verification is established that the fiber is disconnected from any laser or LED source.



**Figure 36. Polishing Connector**

- j. Using a 7X magnifier or microscope supplied in the 1032B5 or 1032B6 Kit, check the tip of the ferrule. No excess epoxy should surround the fiber.

**Note:** If excess epoxy is found, continue to use Type G polishing paper (green) to remove the excess epoxy. Also, be sure there is no epoxy on the beveled edge of the connector ferrule. Step 2 concludes the polishing procedure for multimode fibers. Step 3 is to be performed for singlemode fibers.

**Step 3. Singlemode — Final Polish**

- a. Remove the Type G paper and place a sheet of Type M paper (white) over the the four spacers (clear), on the rubber pad.
  - Note:** Step 3 is critical for excellent return loss.
- b. Dampen the sheet with distilled water (do not flood). Remove the connector from the polishing tool and use the tool to spread the water over the paper using a few strokes.
- c. Place the connector back into the polishing tool and buff polish the connector using 10 figure-8 strokes, approximately 2 inches high and 1 inch wide, using moderate pressure.
- d. Clean fiber end with a wipe dampened with water, then with a second wipe dampened with alcohol.

**Table 2. SC Connector Polishing Overview (Epoxy)**

Step	Polishing Materials	No. of Figure-8 Strokes	Notes
1 (SM & MM)	Type G (green)	As Required	Air polish to remove fiber stub.
2 (SM & MM)	Type G (green) placed over four spacers (clear) over 5" dia. Rubber Pad (300 472 644)	45, then as required	Dry polish to remove epoxy.
3 (SM Only)	Type M paper (white) placed over four spacers (clear) over 5" dia. Rubber Pad (300 472 644)	10	Wet polish. Wet paper with distilled water.
Repair polish, only if needed	Type F (yellow) placed over four spacers (clear) over 5" dia. Rubber Pad (300 472 644)	5 strokes, then as required to remove flaw (10 strokes max.)	Dry polish. For singlemode fibers, after flaw is removed, repeat Step 3

## 7.0 Inspection

### 7.1 Using Microscope to Inspect Fiber

- ATTACH CONNECTOR TO MICROSCOPE** See **Precautions** on **page 2**. Insert the connector tip into the bottom of the microscope. Open the microscope barrels to illuminate the connector tip, and use the side wheel to focus. A high-intensity light may be used at the other end of the fiber to illuminate the core area.

**Caution:** Do not use a laser or LED to illuminate the core area for viewing.

The core may not necessarily illuminate if an epoxy film or bead still exists on the connector end face.

- INSPECT FIBER END** An acceptable fiber end is free of cracks. Voids or scratches must be avoided in the core area. If the fiber is unacceptable, this fiber end must be repaired or reterminated.

- If the connector is not to be used immediately, cover the end with the protective cap.

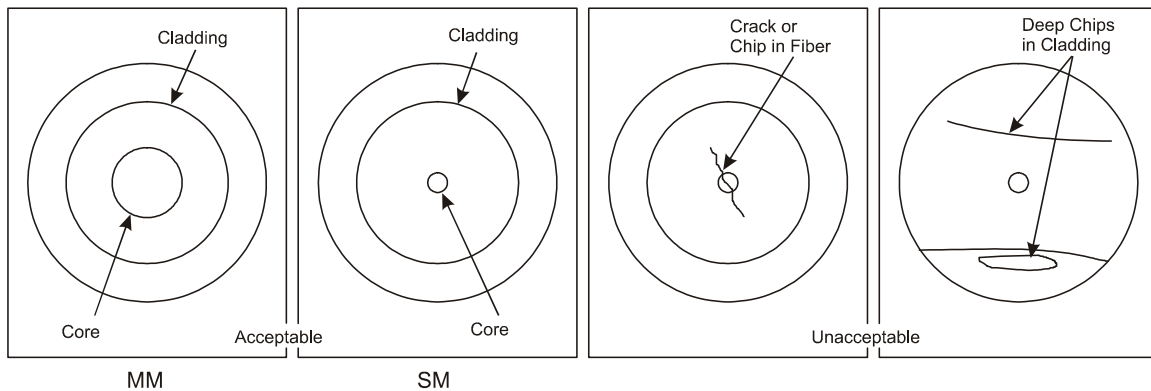
### 7.2 Repairs

- Place a sheet of Type F paper (yellow) over four spacers (clear) placed over the Universal Rubber Polishing Pad (300 472 644).
- Using firm pressure, polish the connector 5 strokes or until the flaw has been removed; however, do not exceed 10 strokes to avoid over polishing the connector. This concludes the repair procedure for multimode connectors. Repeat Step 3 in Section 6.3 for singlemode connectors.

**Note:** Type F paper (5 sheets) is available as comcode 108601469

### 7.3 Snap On Connector Grip

Snap the connector grip onto the polished assembly and cover the end of the connector with the protective cap. This completes the procedure.



**Figure 37. Fiber End Views (Microscope)**

## 8.0 Interconnecting with SC Fiber Optic Connectors

Several interconnecting couplings are available for joining the SC Fiber Optic Connectors. See Ordering Information in this manual.

### 8.1 Cleaning Connector and Coupling

1. **CLEAN END OF CONNECTOR TIP**  
Clean the end and sides of the connector ferrule with a wipe dampened with isopropyl alcohol.

**Important:** If the connector tip is not thoroughly cleaned, the signal performance will be affected.

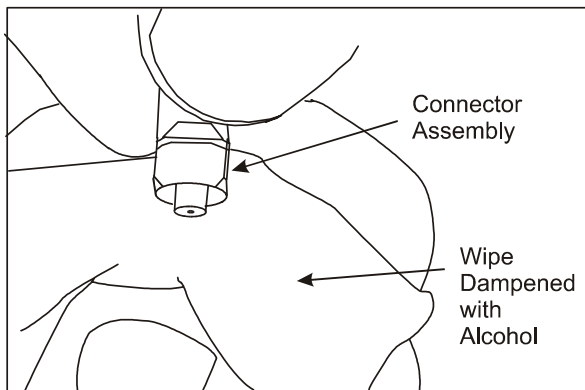


Figure 38. Cleaning Connector Tip

2. **CLEAN INTERIOR OF COUPLING** Use pipe cleaners saturated with isopropyl alcohol to remove debris from the interior of the coupling. *This should be done only if necessary.*

Using canned air, remove any dust particles from the interior of the coupling.

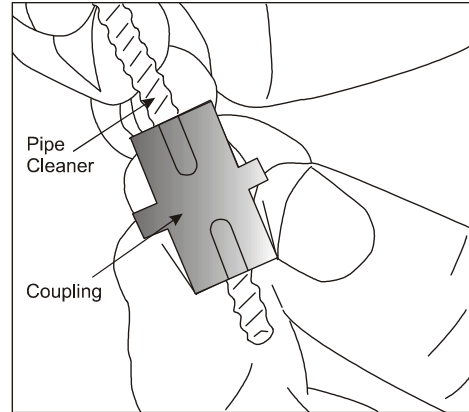


Figure 39. Cleaning Coupling

### 8.2 Installing Coupling on SC Connectors

1. **INSTALL COUPLING** Install the SC connectors onto the coupling by aligning the key on connector grip with the slot in the coupling. Complete the connection by pushing the connectors into the coupling.

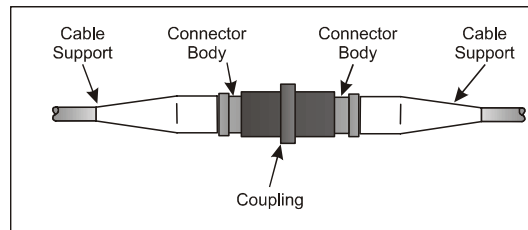


Figure 40. SC Connectors Coupled

2. If a high-loss condition exists, use canned air to reclean the interior of the coupling, and reinstall the coupling as just described.
3. When doing rearrangements or reinsertions of an SC connector, blow any dust from the coupling using canned air. Clean the connector tip with a wipe dampened with isopropyl alcohol and push the connector onto the coupling.

## 9.0 Ordering Information

### 9.1 Tool Kits

**1032B5 Tool Kit** (Comcode 106 705 213) – Contains the following tools and materials for assembly of ST® II, ST® II+, and SC Fiber Optic Connectors.

Kit Quantity	Description	Replacement Comcode	Replacement Quantity
1	1510B Crimping Tool	106 918 998	1 Tool
1	300B Microscope	104 412 077	1 Microscope
1	1510A1 Polishing Tool	108 237 710	1 Tool
12	600B Connector Holders	107 118 549	12 Holders
1	700A Stripping Tool	104 278 478	1 Tool
1	1026A Heat-Strip Tool	105 514 764	1 Tool
2	971A Holder Blocks	104 229 398	1 Holder
1	975A Cleaving Tool	103 808 770	1 Tool
1	Scissors	105 257 364	2 Scissors
1	6-inch Scale	105 257 356	5 Scales
1	Alcohol Bottle	105 257 463	2 Bottles
1	Glass Plate	105 075 618	2 Plates
1	Sheath Removal Tool (R-4366)	105 114 581	1 Tool
1	Instruction Manual	Contact OFS Rep.	1 Manual
15	Micro Clips (1043A)	106 228 455	15 Micro Clips
1	200A Curing Oven	104 055 058	1 Oven
12	1510C SC Connector Holder	106 919 004	12 Fixtures
2	Modified SM/MM SC Grips	107 480 022	10 Grips
1	Rubber Polishing Pad	106 978 992	1 Pad
1	1039A Cut-Length Template	NA	5 Templates
1	1039B Cut-Length Template	107 149 783	5 Templates
1	7X Eye Loupe	Obtain Locally	

**1032B6 Tool Kit** (Comcode 106 919 012) – The 1032B6 Tool Kit is the same as the 1032B5 Tool Kit except the 200A Curing Oven is replaced by the 200A1 Curing Oven for use internationally. The 200A1 oven operates on 220 V 50 Hz. Replacement Comcode for the 200A1 oven is 105 537 690 and is replaced in quantities of one each.

**Universal Rubber Polishing Pad** (Comcode 300 472 644) -- one 5" diameter rubber polishing pad for polishing pre-radiused LC, SC, and ST connectors.

**Heat Tube Assembly** (Comcode 108 261 835) – The Heat Tube Assembly is used with the 200A curing oven for curing ST II+, SC, and LC connectors terminated on to MiniCord cable. The Heat Tubes come in quantities of 6 when ordered.



## 9.2 Consumables

**D-181755 Kit** (Comcode 105 052 047) – Contains the parts required to make a transition from ribbon or LIGHTPACK<sup>®</sup> bundle to individually buffered fibers.

**Universal Polishing Kit** (Comcode 300 472 651)

**Note:** Kit contains enough supplies to field polish 100 singlemode or multimode connectors.

Kit Quantity	Description	
1 Package	Wipes	
15 Syringes	Syringes	
25 Tips	Dispensing Tips	
20 Sheets	Type G Polishing Paper (green)	6 by 6 inches (152 by 152 mm)
10 Sheets	Type M Polishing Paper (white)	5" dia. disc (127 mm dia.)
5 Sheets	3-mil Mylar Spacer (clear)	6 by 6 inches (152 by 152 mm)

**Universal Polishing Kit for Multimode Only** (Comcode 300 486 552)

**Note:** Kit contains enough supplies to field polish 100 multimode connectors.

Kit Quantity	Description	
1 Package	Wipes	
15 Syringes	Syringes	
25 Tips	Dispensing Tips	
20 Sheets	Type G Polishing Paper (green)	6 by 6 inches (152 by 152 mm)
5 Sheets	3-mil Mylar Spacer (clear)	6 by 6 inches (152 by 152 mm)

**Type G Paper** (Comcode 300 472 669) --- Contains 20, 6"x6" sheets of (green) Type G Polishing Paper

**Type M Paper** (Comcode 300472677) --- Contains 10, 5" diameter sheets of (white) Type M Polishing Paper

**Epoxy Kit** (Comcode 105 489 355)— Contains 15 bi-packs of Hysol 0151 heat curable epoxy.

**D-182919 MiniCord<sup>™</sup> Termination Kit (Comcode 107 983 041)** – Contains consumables to terminate MiniCord<sup>™</sup> cable.

Kit Quantity	Description	Replacement Quantity	Replacement Comcode
1	Termination Instructions	NA	Contact OFS Rep.
100	Crimp Sleeves (SC MiniCord <sup>™</sup> Cable)	1000	108 327 552

### 9.3 SC Connectors

Connector Code	Comcode	Fiber Mode	Ferrule (Zirconia)	Description Housing	Cable Size (mm)	Fiber OD (µm)	Packaging
P6000A-Z-125	106 917 438	SM	Domed	Plastic	1.6, 3.0	125	Individual
P6000A-Z-125-100	107 503 856	SM	Domed	Plastic	0.9	125	Bulk
P6001A-Z-125	106 917 586	SM	Domed	Plastic	0.9	125	Individual
P6001A-Z-125-100	107 503 864	SM	Domed	Plastic	0.9	125	Bulk
P6200A-Z-125	106 917 776	MM	Domed	Plastic	1.6, 3.0	125	Individual
P6200A-Z-125-100	107 503 872	MM	Domed	Plastic	0.9	125	Bulk
P6201A-Z-125	106 917 800	MM	Domed	Plastic	0.9	125	Individual
P6201A-Z-125-100	107 503 880	MM	Domed	Plastic	0.9	125	Bulk

### 9.4 Couplings (Standard)

Coupling Code	Comcode	Fiber Type	Coupling Type	Color	Description
C6000A-4	106 703 200	MM/SM	Simplex	Blue	Snap-in coupling
C6000A-5	107 022 980	MM/SM	Simplex	Blue	Snap-in coupling
C6060A-4	106 817 380	MM/SM	Duplex	Blue	Snap-in coupling
C6061A-4	107 118 903	MM	Duplex	Beige	Snap-in coupling
C6070A-4	107 087 967	MM	Duplex	Beige	Snap-in coupling
2A1	106 917 263	NA	Duplex	Black	Quantity of five Duplex Connector Clips
2A1-100	108 136 516	NA	Duplex	Black	Bulk Duplex Connector Clips

## 10. Assistance Information

For more **information**, contact an OFS Sales Representative.

For fiber optic **technical assistance**, call **1-888-FIBER HELP (1-888-342-3743)**.