



A Furukawa Company

Placing Fiber Optic Cable in Underground Plant

Contents	Section
Overview	1
General Rules	2
Precautions	3
Innerduct	4
Cable Lubricant	5
Cable Placing Methods	6
Pulling Fiber Optic Cable	7
Blown Cable Installation	8
Cable Coiling	9
Racking Cable and Innerduct	10

1. Overview

This practice covers the basic guidelines for installation of fiber-optic cable in underground plant. It is intended for personnel with prior experience in planning, engineering, or placement of underground cable. A working familiarity with underground cable requirements, practices, and work operations is necessary as this guide does not cover all aspects of underground construction work.

This document covers cable placing in conduit, innerduct, handholes, and manhole structures. The innerduct may be direct buried or placed in larger diameter conduits. In some applications, the innerduct may be lashed to an aerial strand¹.

Fiber optic cable can be installed using different cable placing methods. This document covers conventional cable placing techniques that are used to pull or blow (cable jetting) the cable into the conduit or innerduct. The basic rules for handling the cable apply regardless of how the cable is installed and are covered in Section 2 - General Rules.

OFS cables are available in both loose-tube and central-tube designs and are available with either dielectric or metallic jackets. Three of the popular designs include Fortex™ DT, AccuRibbon® DC, and AccuTube®+ Rollable Ribbon cables. Please visit www.ofsoptics.com for product data sheets on these and other OFS cable products.

Fiber optic cables may be ordered in bulk lengths or in specific reel lengths to accommodate fixed splice locations. The cable lengths are determined by measuring the distance between splice locations, including allowances for racking in all manholes, plus enough excess to allow for splicing and slack storage coils. Maximum cable lengths are limited by reel capacities and are detailed in the OFS Fiber Optic Products catalog.

2. General Rules

2.1 Route Survey and Inspection

It is recommended that an outside plant engineer conduct a route survey and inspection prior to cable installation. Manholes and ducts should be inspected to determine the optimum splice locations and duct assignments. A detailed installation plan, including cable pulling or blowing locations, intermediate assist points, and cable feed locations should be developed based on the route survey. The installation plan

¹ See OFS IP-052, Aerial Innerduct, for precautions regarding the use of aerial innerduct.

should consider the available equipment and manpower resources, elevation changes, conduit bends and offsets, and recommended installation techniques such as intermediate assist and backfeeds. The type and size of the innerduct should also be considered as this may impact the maximum expected pulling lengths.

2.2 Maximum Rated Cable Load

The maximum rated cable load (MRCL) for most OFS outside plant fiber optic cables is 600 lb; however, the cable documentation should always be checked because lower values of MRCL may apply for some cables. When using pulling equipment to install cable, measures should be taken to ensure that the MRCL is not exceeded. This includes the use of breakaway swivels, hydraulic pressure relief valves, and electronic tension control systems. When using breakaway swivels, they should always be checked to confirm that the correct breakaway pins are installed. Hydraulic pressure relief valves and electronic tension control systems should be calibrated on a regular basis to ensure that they release at the proper tensile force.

Commercial software is available that can be used to estimate the cable installation tension². However, to obtain accurate predictions of installation tension, these programs require detailed descriptions of the conduit geometry and estimates of friction coefficients. Depending on actual field conditions, the actual cable installation tension may differ from the estimated tension.

2.3 Minimum Bend Diameter

The minimum bend diameters³ for OFS cables are defined for both dynamic and static conditions. The dynamic condition applies during installation when a cable may be exposed to the MRCL, e.g., while pulling the cable around a sheave or capstan. The static condition applies to a cable that is exposed to less than 30% of the MRCL (< 180 lb). An example of this condition is an installed cable that is racked through a manhole or on an equipment frame. Minimum coil diameters are also specified for long-term storage of slack cable. In some cases temporary bending of cable storage-coils into smaller diameters may be necessary to pass cable coils into a manhole (Figure 1); however, the cable should not be bent smaller than that recommended for static conditions under any circumstance. Cable minimum bend diameters are generally expressed as a multiple of the cable outside diameter (OD) and are summarized in Table 1. For information regarding specific dimensions, please visit www.ofsoptics.com to view cable data sheets or contact OFS Customer Service at 1-888-FIBERHELP (1-888-342-3743).

Table 1 – Minimum Bend Diameters for OFS Cable			
Loose Tube Cables	Minimum Bend Diameter		Minimum Storage Coil Diameter
	Static	Dynamic	
DryBlock®, Fortex™ DT	20 × OD	30 × OD	20 × OD (but no less than 12")
AccuTube® Ribbon in Loose Tube	30 × OD	30 × OD	30 × OD
AccuTube+ Rollable Ribbon	30 × OD	30 × OD	30 × OD

² Polywater Pull-Planner 4.0 Cable Pulling Software. Polywater is a registered trademark and Pull-Planner is a trademark of American Polywater Corporation, Stillwater, MN.

³ Some cable manufacturers specify minimum bend radius rather than minimum bend diameter. Minimum bend diameter can be converted to minimum bend radius by dividing the minimum bend diameter by two. For example, the minimum bend radii for OFS DryBlock™ loose tube cables are 10 × OD and 15 × OD, respectively, for static and dynamic conditions.

Table 1 (cont.) – Minimum Bend Diameters for OFS Cable			
Central Tube Cables	Minimum Bend Diameter		Minimum Storage Coil Diameter
	Static	Dynamic	
LightPack® LXE	20 × OD	40 × OD	18 inches
AccuRibbon® ≤ 216 fibers	20 × OD	40 × OD	18 inches
AccuRibbon® > 216 fibers	30 × OD	40 × OD	40 × OD
DuctSaver® Rollable Ribbon	20 × OD	30 × OD	20 × OD
AccuRoll™ Rollable Ribbon	30 × OD	30 × OD	30 × OD (but no less than 18")

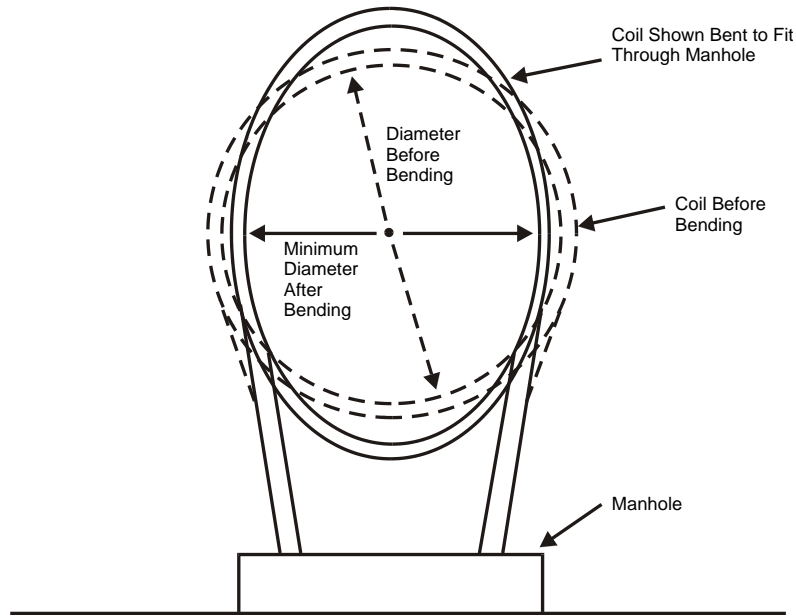

Figure 1 – Temporary bending of cable storage-coils while passing the coils into a manhole.

2.4 Temperature Limits

Storage and installation of OFS fiber optic cable is limited to the temperature ranges listed in Table 2. Be aware that solar heating due to sunlight exposure can increase the cable temperature well above the ambient temperature. Leave the protective thermal wrap on the cable reel until just prior to cable installation. Do not store cable on heat absorbing surfaces such as black asphalt. When possible, place figure-eights in shaded areas or on solar-reflective tarps to prevent excessive heating of the cable.

Table 2 – Installation & Storage Temperatures	
Installation	-30°C to 60°C (-22°F to 140°F)
Storage/Shipping	-40°C to 75°C (-40°F to 167°F)

3. Precautions

Before starting any underground cable placing operations, all personnel must be thoroughly familiar with local company safety practices. Practices covering the following procedures should be given special emphasis:

- Guarding and protecting work areas
- Testing and ventilating manholes
- Precautions pertaining to smoking or use of open flames around manholes
- Removing and replacing manhole covers
- Hand signals used in outside plant construction work

To avoid personnel injury and/or cable damage, all personnel must be trained in the safe operation of the required equipment and construction apparatus.

Adequate communications must be established and maintained between the cable feed location, the pulling equipment, and all manned intermediate manholes during the cable placing operation.

Practice good housekeeping. Store all work material away from the manhole so they will not fall into the manhole or unnecessarily interfere with pedestrian or vehicular traffic.

Employees should not enter a manhole or remain in a manhole during the placing or removal of any cable. An exception is made while placing fiber optic cable under the following conditions:

- To provide manual assistance in pull-through manholes. **Caution: Do not provide manual assistance in manholes rigged with blocks or sheaves.**
- To observe alignment of manhole rigging equipment. **Caution: Remain clear of the rigging equipment while the cable or winch line is under tension.**
- To assist in cable alignment at the feed manhole.

4. Innerduct

Fiber optic cable is most often placed in a small-diameter innerduct rather than a large-diameter conduit. For existing conduit structures, multiple innerducts can be placed in a single conduit to provide multiple cable paths in the duct. Innerduct is also recommended because it provides a clean continuous path for the installation of the fiber optic cable.

Innerduct is available in different sizes and in a variety of configurations, e.g., smooth-walled, ribbed, and corrugated. The proper choice of innerduct type depends on the installation environment (direct buried or in conduit) and the cable installation method (pulling or blowing). Many manufacturers provide pre-lubricated innerduct and pre-installed rope or pulling tape. Pressure rated innerduct is required for blown cable applications. Consult the innerduct and/or equipment manufacturer regarding special requirements for blown cable applications.

Following installation, the ends of the innerduct should be capped to keep out dirt. If the innerduct is discontinuous along the cable route, the ends of innerduct can be joined to provide a continuous path for cable installation. Airtight and pressure rated couplings are required for blown cable applications. Consult the innerduct and/or equipment manufacturer regarding the proper choice of innerduct coupling.

Innerduct should not be racked in intermediate manholes during cable installation because the additional curvature created by the racked innerduct will increase the cable installation tension. Instead, the innerduct should be positioned and tied straight and continuous through all intermediate locations. Following cable installation, the innerduct can be permanently racked in the intermediate manhole locations. An exception to this rule applies for blown cable applications. In this case, there is no need to straighten the innerduct prior to the cable blowing operation and the innerduct can remain racked during cable installation.

4.1 Diameter Ratio and Area Ratio

Diameter ratio and/or area ratio are used to determine the optimal cable OD that should be installed in an innerduct. Either ratio can be used, but consistently using one or the other is important to avoid confusion. Diameter ratio and area ratio are calculated as follows where the innerduct ID and cable OD are shown in Figure 2.

$$\text{Diameter Ratio (\%)} = \frac{\text{Cable OD}}{\text{Innerduct ID}} \times 100$$

$$\text{Area Ratio (\%)} = \left(\frac{\text{Cable OD}}{\text{Innerduct ID}} \right)^2 \times 100$$

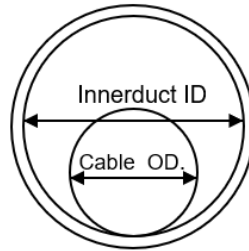

Figure 2 – Cable and innerduct dimensions for use in diameter and area ratio calculations.

Optimal values of diameter and area ratio are shown in Table 2 for cable pulling and blowing applications of standard OSP and indoor/outdoor cables. The diameter (area) ratios in Table 2 are recommended for applications where it is desirable to maximize cable installation length. Note that microcable recommendations vary slightly from these values and are provided in IP-055, *Microcable Installation*.

Table 2 – Optimal Values of Diameter and Area Ratio for Cable Pulling and Cable Blowing Applications for Standard OSP Cable		
Application	Diameter Ratio	Area Ratio
Cable Pulling	< 75%	< 56%
Cable Blowing	50 – 75%	25 – 56%

In some circumstances, it may be desirable to maximize the fiber count in an existing duct and exceed the diameter (area) ratios shown in Table 2. This is a common practice and many successful installations have been accomplished with higher diameter (area) ratios. However, in these situations, be aware that higher diameter (area) ratios may lead to more difficult cable installations. OFS recommends the following preparatory steps before attempting to install large diameter cables into small ducts.

1. Measure and confirm the inside diameter of the duct. The nominal and actual ID of the duct may differ depending on the type of duct (corrugated vs. smooth wall) and SDR (standard dimension ratio) rating.
2. Confirm that the cable and pulling grip fit into the duct. If the cable pulling grip creates an interference fit with the innerduct it may be possible to reduce the overall diameter by removing the cable jacket prior to attaching the pulling grip. Refer to OFS IP-013A, *Pulling Grip Attachment*, for instructions regarding removal of the outer cable jacket and attachment of the cable pulling grip.
3. Inspect the cable route prior to installation. Select feed and pull locations to minimize the number of turn-angles in the cable path. Confirm that intermediate manholes or handholes are available and accessible so that intermediate assist equipment can be used as needed.

4. Proof the duct to confirm there are no obstructions. Proof the duct by pulling or blowing a short section of cable (and pulling grip if applicable) through the duct.
5. Clean the duct prior to cable installation. Remove water, dirt, and debris by pulling or blowing a foam plug through the duct. Repeat as necessary.
6. Spread cable lubricant throughout the duct by pouring directly into the duct ahead of the cable or blow lubricant through the duct prior to cable installation. Apply lubricant to the cable during installation.

4.2 Direct Buried Applications

Studies have shown that vertical undulations in direct buried innerduct can greatly increase the required cable installation forces. Consequently, a minimum innerduct ID of 1-1/2 inches is recommended for direct buried applications. Either smooth-bore or ribbed innerduct is recommended. Corrugated innerduct is not recommended for direct-buried applications.

5. Cable Lubricant

Cable lubricant should be used when placing fiber optic cables. Recommended cable lubricants include Polywater⁴, Hydralube⁵, and similar cable lubricants that are compatible with polyethylene cable jackets. Both the winch line (or pulling rope) and the cable should be lubricated. The lubricant should be poured into the innerduct ahead of the swivel connector so that the swivel connector distributes the lubricant through the innerduct. The cable lubricant should also be applied directly to the winch line and cable as they enter the conduit. If the innerduct is open at intermediate manholes, the appropriate proportion of lubricant should be applied at each manhole. Follow the lubricant manufacturer's instructions for the recommended quantity of lubricant based on the innerduct size and length of the pull.

Standard cable-pulling lubricants may not be compatible with cable blowing techniques. If the cable is installed using cable-blowing methods, cable lubricants should be selected and used in accordance with recommendations provided by the blowing equipment manufacturer.

Caution: Liquid detergents may cause stress cracking of the polyethylene cable jacket and are not recommended for use as cable lubricant.

6. Cable Placing Methods

6.1 Backfeed Technique

The backfeed technique is a common installation method that is used to divide the cable installation into two separate pulls as shown in Figure 3. Use of this technique can effectively double the distance between cable splices by dividing the cable pull into two separate placing operations. To begin, the cable reel is positioned near the middle of the cable route and the first half of cable is installed in a typical fashion (Figure 3 – Step 1). Next, the inside end of the cable is accessed by removing the remaining cable from the reel and storing it on the ground in a figure-eight (Figure 3 – Step 2). Finally, the second half of the cable is fed into the duct from the figure-eight (Figure 3 – Step 3) and pulled to the second splice location. The backfeed technique may also be used near equipment offices when one end of the cable must be pulled by hand into the building, or at manhole locations where the cable route changes direction.

⁴ Polywater is a registered trademark of American Polywater Corporation, Stillwater, MN.

⁵ Hydralube is a registered trademark of Dura-Line Corporation, Knoxville, TN.

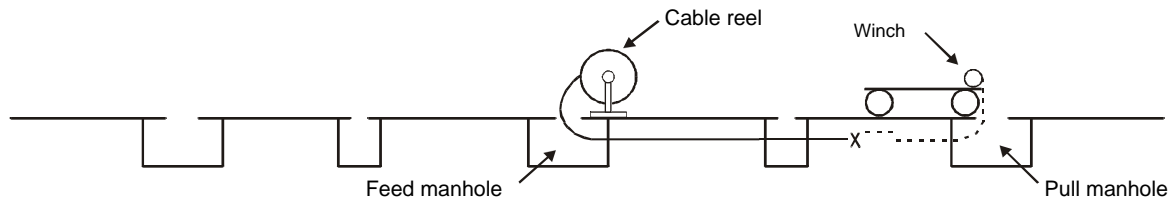

Step 1 - Pull or blow cable into first half of the cable route.

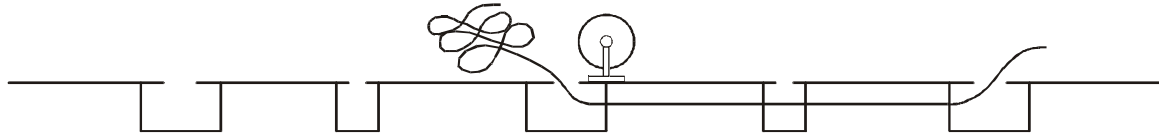

Step 2 - Remove the cable from the reel and store in a figure-eight.

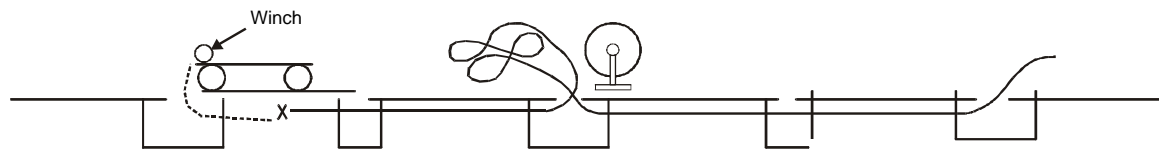

Step 3 - Pull or blow cable from the figure-eight into the second half of the cable route.

Figure 3 - Backfeed Technique

6.2 Forward-Feed Technique

In the forward-feed technique, the leading end of the cable and excess cable length are pulled out of the innerduct at an intermediate manhole and stored on the ground in a figure-eight (Figure 4 – Step 1). The cable placing equipment is then repositioned, the figure-eight is turned over to access the outside cable end, and the cable is fed back into the innerduct and pulled forward into the next duct section (Figure 4 – Steps 2 & 3). This technique can be used multiple times during a cable installation to greatly increase the distance between cable splices.

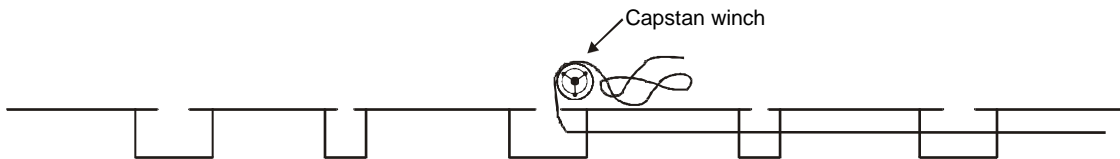

Step 1. Pull or blow cable to an intermediate manhole and store the cable in a figure-eight.

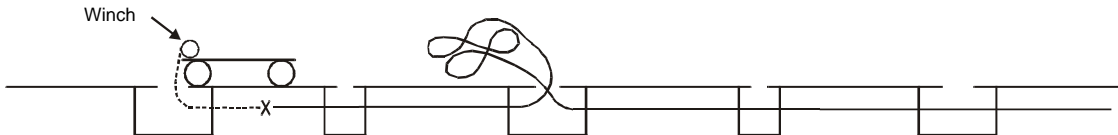

Step 2. Reposition the placing equipment and flip the figure-eight stack to access the end of the cable.

Step 3. Feed the cable into the innerduct and pull or blow the cable to the splice location.

Figure 4 – Forward-Feed Technique

6.3 Figure-Eight Installation Techniques

If figure-eight techniques are used during cable installation, the cable should be handled manually and stored on the ground. Place the cable on tarps to prevent damage from gravel, rocks, or other abrasive surfaces (Figure 5). Tarps should also be used in muddy conditions to keep the cable clean. Be sure to allow enough area to accommodate the cable length to be stored and provide sufficient personnel to maintain the required minimum-bending diameter as well as avoid kinking or otherwise damaging the cable.

If the cable has been figure-eighted in preparation for a forward feed, the figure-eight must be flipped over to access the outside cable end. Provide sufficient personnel to avoid kinking the cable as the figure-eight is flipped over. When removing the cable from the figure-eight, use care to avoid kinking the cable and violating the minimum-bending diameter.



Figure 5 - Cable figure-eight.

When figure-eighting heavy cables (264 fibers or more), the cable stack should be offset to prevent sheath dents and cable damage. Although sheath dents do not typically damage fibers, this type of cosmetic damage is undesirable. When utilizing the offset method, each crossover point of the cable stack should be offset about 2 inches instead of being stacked directly on top of each other (Figures 6 and 7). When the height of the standard figure-eight exceeds 2 feet, then a second figure-eight stack must be started.

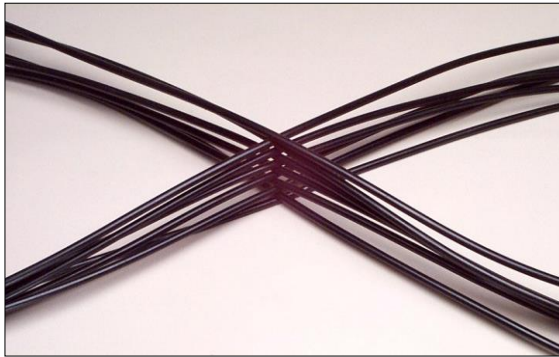

Figure 6 – Standard Figure-Eight

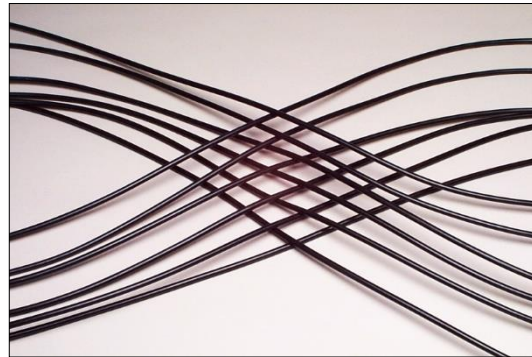

Figure 7 – Offset Figure-Eight

Caution: “Figure-eight eliminator” equipment, which is used to eliminate manual figure-eight procedures, has been found to cause cable and fiber damage. This equipment typically uses a mechanized cable delivery system to wrap the fiber optic cable onto a stationary drum. **This type of equipment is not recommended for use with OFS fiber optic cable. Cable damage resulting from the use of this equipment is not covered by OFS cable warranty.**

6.4 Handholes

Handholes are frequently used to provide access to cable splices and slack storage coils. On long cable pulls, handholes may be used to facilitate intermediate-assist placing operations. The intermediate-assist handholes are typically installed near obstacles or at a predetermined spacing that coincides with the maximum expected cable installation length.

All handholes must be large enough to accommodate the minimum bend diameters as required for cable placing and coiling operations. The splice closure dimensions must also be considered when sizing the handhole. Innerducts should enter the handhole near the corners so that the full width of the handhole can be used to coil the cable.

Prior to cable installation, the innerducts should be trimmed as necessary to accommodate cable installation. Following installation, the innerduct should be trimmed so that only about six inches of innerduct protrudes into the handhole. Unused innerducts should always be capped.

7. Pulling Fiber Optic Cable

The following instructions assume general familiarity with outside plant cable placing procedures. They also assume that the innerduct is in place and a lubricated pulling tape or rope has been installed in the innerduct. **Caution: Adequate communications must be established and maintained between the cable feed location, the pulling equipment, and all manned intermediate manholes during cable placing operations.**

7.1 Feed Manhole

Mount the cable reel on the reel carrier so that the cable feeds off the top of the reel. Position the cable reel adjacent to the manhole and in-line with the innerduct. The cable reel should be positioned close enough to the manhole so that excessive cable length is not dragging on the ground, but far enough

away to maintain slack cable in the event of a sudden start or stop during the pulling operation. A distance of 10 – 15 feet is generally sufficient. Attach the pull line to the fiber optic cable using a cable grip and swivel connector. **Caution: A breakaway swivel connector (Figure 8) is required if a tension limited winch is not used to pull the cable.** Ensure that the correct pins are installed in the breakaway swivel to match the MRCL (typically 600 lb). Do not pull the breakaway swivel over sheaves or capstans as this may cause the swivel to break at less than the rated capacity. Wrap vinyl tape over the allen screws of the swivel connector to prevent the screws from backing out. Be sure the connector swivels freely. Also wrap vinyl tape over the back end of the pulling grip and onto the cable to prevent the grip from slipping off the cable. Apply a warning mark to the pull line about 20 ft in front of the cable. This mark provides a warning to other members of the placing crew that the cable is approaching intermediate or pull-manhole locations.

Clear the cable path of any tools or equipment that may snag the cable. Pour cable lubricant into the innerduct ahead of the pulling swivel and apply lubricant directly to the cable as recommended. Spin the cable reel by hand during the pull and maintain zero back-tension on the cable. Feed the cable by hand as required to maintain a smooth flow into the manhole and innerduct and prevent snags on manhole ladders and hardware. Do not feed the cable through snatch blocks or cable sheaves and do not permit slack loops to form on the cable reel. Mechanical reel drives may be used but they must be continuously monitored to maintain proper cable payoff as described above.

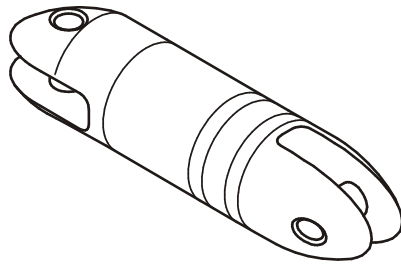

Figure 8 - Breakaway Swivel Connector

7.2 Intermediate Manholes

The innerduct in intermediate manholes may be continuous through the manhole or it may be interrupted. In either case, the innerduct should be positioned in a straight path from entry duct to exit duct.

If the innerduct is continuous and has been racked, remove the innerduct ties and straighten the innerduct through the manhole. If necessary, slack innerduct can be cut out using an innerduct cutter. Secure the innerduct in the manhole to prevent it from creeping into the main duct during cable placing operations.

If the innerduct is not continuous and the entry and exit ducts are aligned, the innerduct may be joined with an innerduct coupling. If the innerduct ends are not long enough to join together, a short section of innerduct may be spliced in with couplings. Joining the innerduct will provide a smooth transition for the cable and prevent cable lubricant from spilling out of the innerduct.

If the innerduct is not continuous and will not be joined, tie the innerduct in place to maintain alignment and prevent movement into or out of the main duct during cable placing operations. Cable shoes or guides must be used as required to prevent the cable from dragging over sharp corners. As the leading end of the cable passes across the innerduct gap, a craftsman is required to observe, and if necessary, align the pulling swivel and cable grip as they re-enter the innerduct. If necessary, additional lubricant can be applied to the cable as it moves across the innerduct gap.

If the entry and exit ducts are offset in the intermediate manhole, cable sheaves (or quadrant blocks for

central tube cables only) must be rigged to support the minimum bend diameter of the cable. The cable sheaves and quadrant blocks must meet the minimum bend diameter requirements listed in Table 1. Trim the innerduct as required to provide ample clearance between innerduct and the cable sheaves. Secure the innerduct to prevent it from creeping and hitting the cable sheaves. **Caution: Craft persons must exit pull-through manholes during cable pulling operations if the manhole is rigged with cable sheaves or quadrants.**

7.3 Pull Manhole

OFS recommends the use of tension-limited winches for pulling fiber optic cable. The tension control may be accomplished by electrical, mechanical, or hydraulic methods. In any case, the tension-limiting device must be routinely calibrated as recommended by the equipment manufacturer. Cable winches that display cable tension but do not have automatic cutoff are not sufficient to protect the cable. If a tension-limited winch is not used, a breakaway swivel must be used to connect the fiber optic cable to the pulling line. **Caution: Fiber optic cable is not intended to be wound under tension onto a cable reel. If cable must be wound onto a reel, a capstan winch should first be used to pull the cable, and subsequently the cable can be wound onto the reel as it pays off the low tension side of the capstan. Be sure to maintain slack between the capstan and the cable reel as the cable is wound onto the reel.**

Position the cable winch at the pull manhole in line with the manhole opening and innerduct. Rig the pull manhole with cable sheaves (or quadrant blocks for central tube cables only) to guide the pull rope out of the innerduct, through the manhole, and up to the cable winch. Secure the innerduct with temporary ties so it will remain in place and not creep out of the main duct during cable installation. Provide ample clearance between the end of the innerduct and the cable sheaves to accommodate elongation of the innerduct.

Start the pull by gradually engaging the winch at slow speed until the winch line begins to move. After the cable enters the innerduct at the feed manhole, the speed may be gradually increased. Maintain a speed that is safe and manageable at both the feed and pull manholes. **Caution: Advise all crew members prior to starting or stopping the cable pull.**

Observe the pull line and monitor the cable tension during the cable installation. Be alert to other crew members in case they need to change the pulling speed or stop the installation. Watch for the warning mark on the pull line and reduce the pulling speed when the mark appears in the pull manhole. Be prepared to stop the pull as cable enters the manhole. Assuming the manhole is rigged with appropriate cable sheaves or quadrant blocks, excess cable length can be pulled around the sheaves and out of the manhole. Pull enough cable length out of the manhole to provide for slack storage and splicing purposes.

If high pulling tensions are encountered, placing crews must be prepared to provide manual assistance or setup a capstan assist winch at an intermediate manhole. Manual assist is most effective when applied close to the feed location. Capstan assist winches should be setup at intermediate manholes where the expected installation tension will not exceed the MRCL (typically 600 lb).

7.4 Capstan Winches

7.4.1 General

Breakaway swivels do not protect the fiber-optic cable after the cable pulling-eye passes the intermediate capstan winch; therefore, intermediate-assist capstan winches must be tension-limited. The capstan must also meet the minimum cable bend-diameters summarized in Table 1. Finally, to prevent lubricated cable from slipping on the capstan, the capstan should be wide enough to accommodate seven wraps of cable.

7.4.2 Set-up

The capstan winches should be positioned along the cable route where the expected pulling tension will be 600 pounds or less. Proper positioning of the capstans prior to the start of the pull will eliminate construction delays caused when an unplanned intermediate capstan assist must be added to the placing operation.

The “pull side” of the intermediate assist manhole must be rigged with cable sheaves (or quadrant blocks for central tube cable only) to guide the cable out of the manhole and up to the capstan winch. The “feed side” of the manhole must be rigged so that slack cable can be fed back into the innerduct.

7.4.3 Slack Cable Loop

During the pulling operation, a slack loop of cable must be maintained on the pull-off side of the capstan as shown in Figure 9. The slack loop should be handled manually and the minimum recommended length of the slack loop is 20 feet. The slack loop serves as a buffer and allows the equipment operator to adjust the cable pulling speed to match that of the adjacent capstan winches. Failure to maintain the slack loop may cause cable damage during the placing operation.

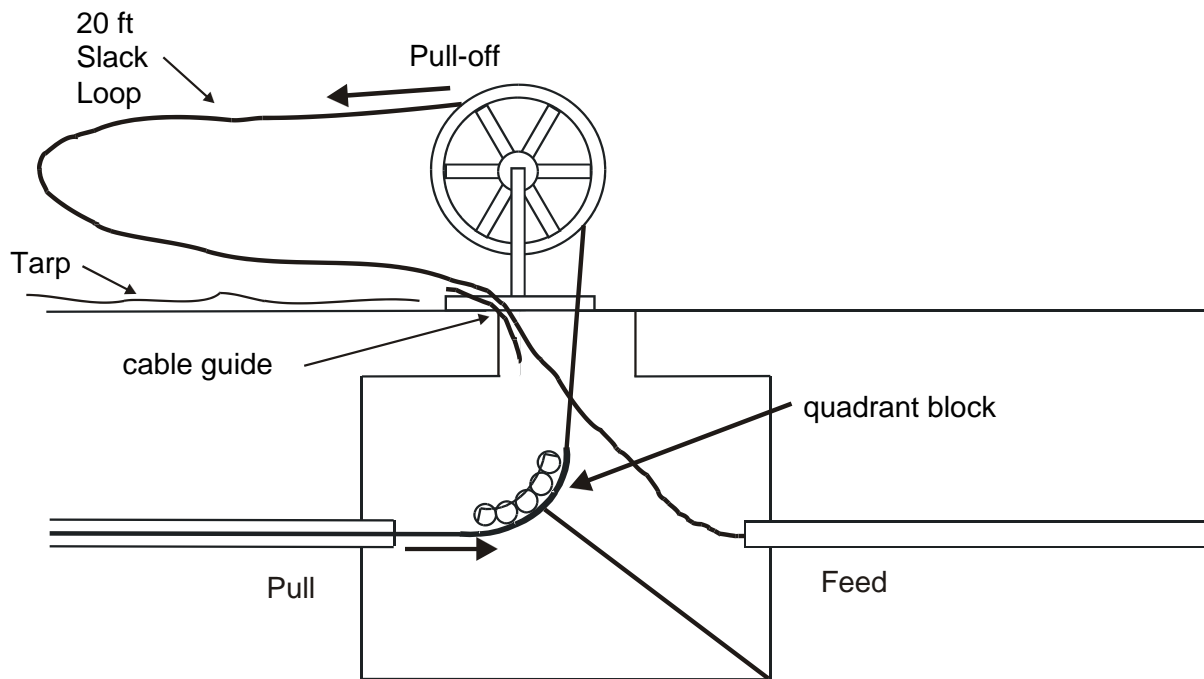

Figure 9 - Intermediate Manhole Set-up

7.4.4 Adding Intermediate Capstans

If an intermediate capstan is added during the cable pull and the cable pulling eye has already passed through the manhole, a loop of slack cable must be pulled to the intermediate manhole before cable is wrapped on the capstan (see Figure 10). A 75-foot loop is required for seven cable wraps on a 30" diameter capstan, and a 90-foot loop is required for seven cable wraps on a 40" diameter capstan.

Alternatively, a 30-foot loop can be pulled to the intermediate manhole and two wraps of cable placed on the capstan. The capstan can then be used to pull an additional 30 feet of cable so that two more cable wraps can be added to the capstan. The procedure is repeated one more time to add the final wraps of cable.

CAUTION: Do not repetitively pull short lengths of cable and add a single cable wrap to the capstan. This procedure induces severe twisting into the cable and may cause cable damage. A longer loop of slack cable must be pulled to the intermediate manhole before cable wraps are added to the capstan as described above.

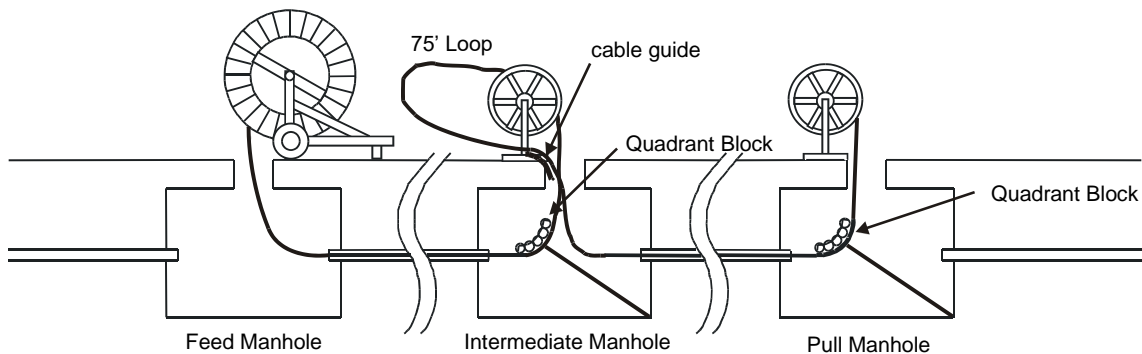

Figure 10 – Adding an Intermediate Assist Capstan

7.4.5 Removing Cable from Intermediate Capstan Assist Winch

At the conclusion of the pull, the cable on the capstan is twist free. However, one twist per wrap will be generated in the cable if it is removed from the capstan and straightened.

If no cable slack is to be left at the intermediate assist point, the cable wraps on the capstan should be removed from the capstan and the twist evenly distributed throughout the slack cable. This spreads the twists from the capstan evenly over the entire length of cable. The cable can then be carefully pulled into the conduit run.

If a coil of cable is to be stored in the manhole, the wraps of cable on the capstan should be removed and sized in diameter as required by Table 1. The cable should not be straightened during this step. Instead, the cable should remain coiled and any additional slack cable can be added using one of the coiling methods shown in **Section 9 – Cable Coiling**.

8. Blown Cable Installation

Cable blowing systems use high-pressure, high-velocity airflow combined with a pushing force to install the cable. A hydraulic or pneumatic powered drive wheel or drive belt is used to push the cable into the innerduct at the feed manhole. Controls and gauges on the cable blowing system allow the operator to monitor and adjust the air flow and push force that is exerted on the cable. Some cable jetting systems use a plug at the cable end to capture the compressed air and generate a small pulling force on the end of the cable.

Unlike traditional pulling methods that apply a high concentrated force to the end of the cable, cable blowing systems use distributed forces to install the cable. The fiber cable benefits from these systems because it is exposed to relatively low installation forces and subsequent low residual stress. In general, this placing method is very gentle on the cable; however, care must be taken to assure that the cable is not damaged by the drive wheels or belts. In particular, the cable can be damaged by spinning the drive wheels or drive belt on the cable, and the cable can be buckled in the innerduct by applying too much thrust (cable pushing force) to the cable. Relatively simple test procedures can be used to determine the maximum operating speeds and pressures that can be safely used with the cable. These operational limits must be established using samples of the cable and innerduct that will be used during the installation. Consult the equipment documentation or equipment manufacturer for specific instructions regarding the test and calibration procedures.

Precision seals and grommets are used in the cable blowing equipment to prevent or minimize air leakage around the cable and innerduct. Consult the equipment documentation for the correct seals and grommets that should be used for your specific cable and innerduct. Inspect and replace worn grommets as required prior to cable installation.

The innerduct used for blown cable installation must be continuous through all intermediate manholes. Couplings can be used to join innerduct in intermediate manholes but they must withstand the high pressure air that is used during cable installation. Consult your innerduct supplier or blowing equipment manufacturer to obtain innerduct couplings that are suitable for your application. Since the maximum cable blowing lengths are not significantly affected by duct curvature, the innerduct can remain racked in intermediate manholes during blown cable installations.

The typical cable blowing process consists of the following steps. These procedures may vary among equipment suppliers so always consult the installation practices provided by the equipment manufacturer.

Caution: Always check high-pressure air hoses, fittings, and couplings prior to cable installation. Repair damaged hoses and fittings as required. Use safety pins on high pressure hose couplings to prevent accidental disconnects. Eye and ear protection should always be worn when working with high pressure air equipment.

1. A successful blown-cable installation requires that the duct be airtight and free of obstructions. Pressurize the innerduct and confirm that air is exiting the far end of the innerduct. If liberal air flow is not observed at the far end, check the innerduct and innerduct couplings for air leaks. Repair as necessary. Next, blow a foam carrier through the innerduct to confirm its integrity and push out any dirt and water that may have accumulated. Repeat as required to push dirt and water out of the innerduct. **Caution: Water, dirt, and the foam carrier may exit the end of the innerduct at high velocity. Fasten a mesh bag over the end of the innerduct to capture the foam carrier and any debris that may be blown out. Do not look into the open end of the innerduct and make sure the innerduct is pointed away from all crew and bystanders.**
2. Pour the recommended amount of cable lubricant into the innerduct and blow a second foam carrier through the innerduct to spread the lubricant.
3. Prepare the cable for installation by attaching a bullet or piston to the end of the cable as recommended by the equipment manufacturer. Pour the recommended quantity of cable lubricant into the innerduct ahead of the cable. Feed the cable through the blowing machine and into the innerduct. Push about 30 - 50 feet of cable into the innerduct by hand.
4. Start the installation using only the drive wheels or drive belt and push about 200 feet of cable into the innerduct. Apply air pressure and adjust operating speeds and pressures as required. Do not exceed the maximum operating parameters established by the pre-installation test and calibration procedures. Standard backfeed and forward-feed placing techniques (see Figures 11 and 12) can be used if the cable cannot be installed in one continuous length. As with intermediate capstan-assists, always provide a slack loop at each intermediate blower location.

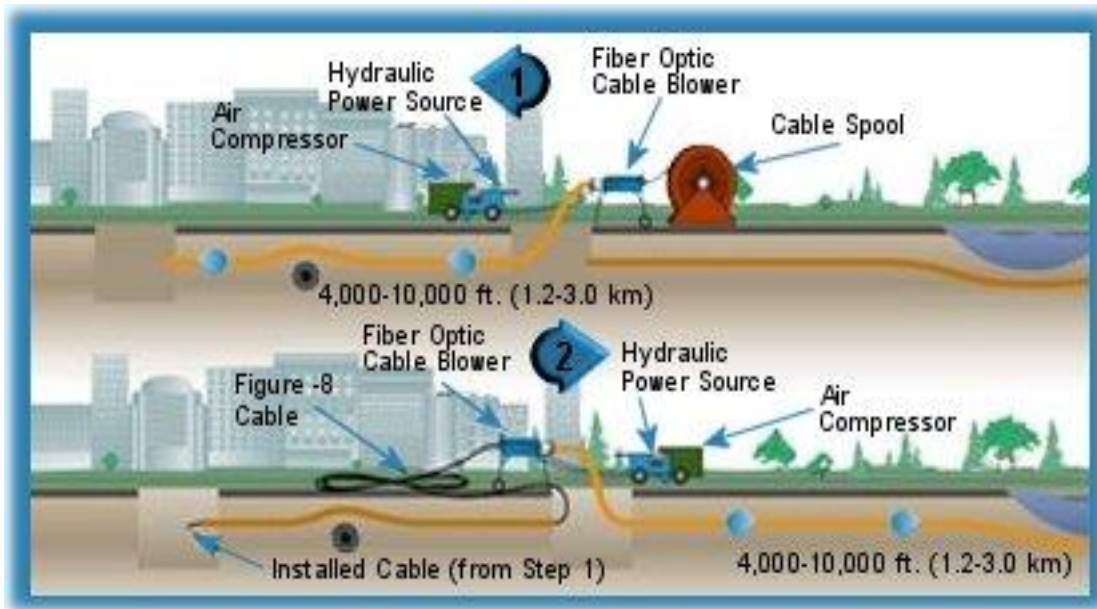

Graphic courtesy of Condux International

Figure 11 - Backfeed installation using cable blowing equipment.

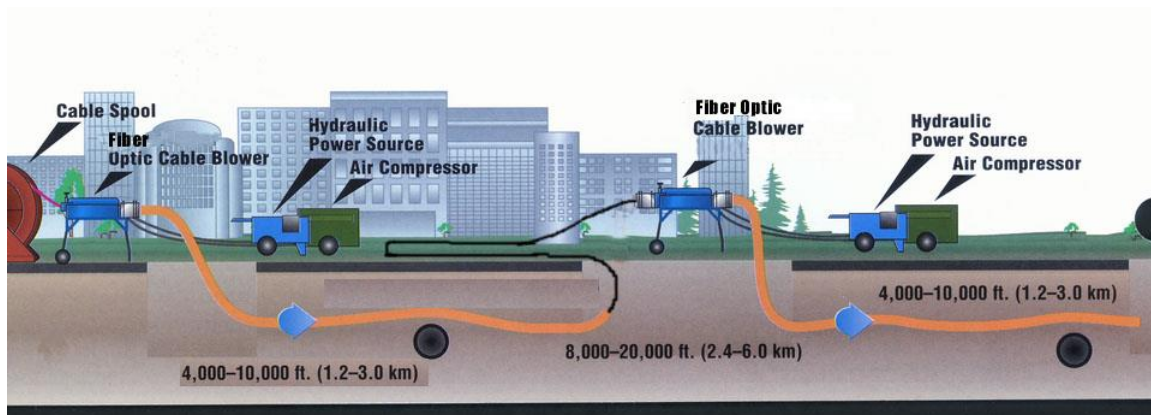

Graphic courtesy of Condux International

Figure 12 – Forward-feed installation using two cable blowers.

9. Cable Coiling

9.1 Coils Stored at Intermediate Holes

Many end users require that coils of slack cable be stored in intermediate manholes along the cable route. These slack storage coils are used for future branch splices or route rearrangements. It is important that the coiling method accommodates the proper coil diameter and does not introduce kinking or excessive twist into the cable. The appropriate coiling method will depend on the size, length, and bending-stiffness of the cable being installed. The following coiling methods are recommended for use in intermediate manhole applications.

- Fold-Over Method
- Tear Drop Method
- Garden Hose Method

9.2 Fold-Over Method

The **Fold-Over Method** (see Figure 13) is recommended for storing moderate lengths of slack cable. Form a cable bight and then twist the bight to form the first cable coil. Fold the coil over to form the second cable coil. Continue to form additional coils by folding the coil in the same direction and alternating the position of the cable in each leg (over and then under the other leg) to form a twist free coil. Reverse the coiling procedure to unfold the coil into a twist free cable bight.

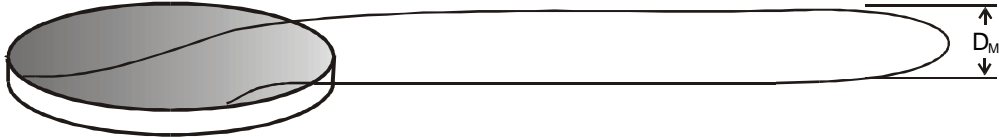

Step 1. Lay out cable bight. Be sure to observe the minimum bend diameter.

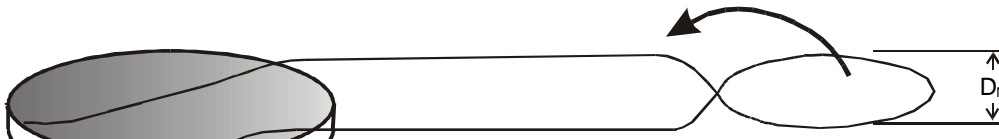

Step 2. Twist the cable bight to form first coil.

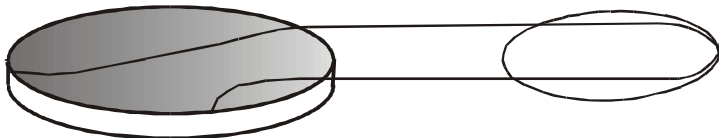

Step 3. Fold over first coil to form the second coil.



Step 4. Adjust size and tape the coils.

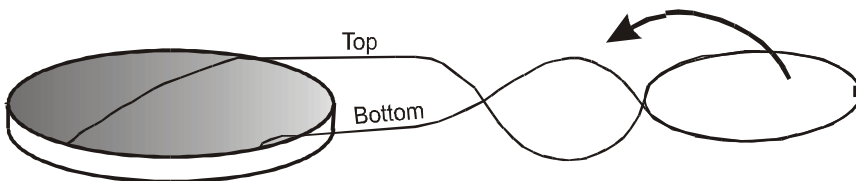

Step 5. Twist the cable bight to start the next coil and fold over.

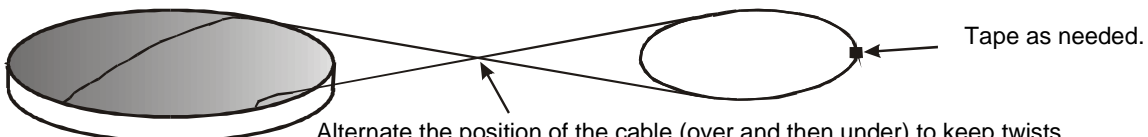

Alternate the position of the cable (over and then under) to keep twists from accumulating in the coil. You may also rotate the cable bight to remove any accumulated twists.

Step 6. Continue to form and fold coils until all of the cable has been coiled.

Figure 13 - Fold-Over Method

9.3 Teardrop Method

The teardrop coiling method (Figure 14) is recommended for storing longer lengths of cable since it is easier to roll the cable than perform repetitive folding operations. The cable is stored twist free by rolling the cable bight in a manner similar to that used on the cable end. **Caution: In order to meet the minimum bending requirement of the “teardrops”, this coiling method may require a larger coil diameter than listed in Table 1. See Step 4 in Figure 14 for further details.**

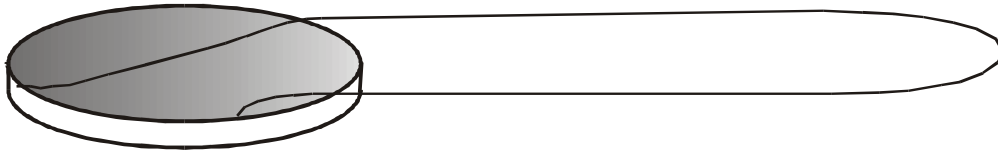

Step 1. Lay out cable bight.

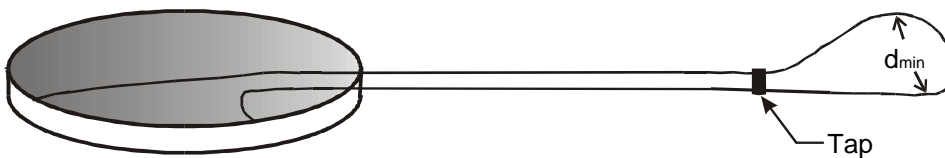

Step 2. Form teardrop and tape. Note: d_{min} = the minimum bend diameter for static conditions listed in Table 1.

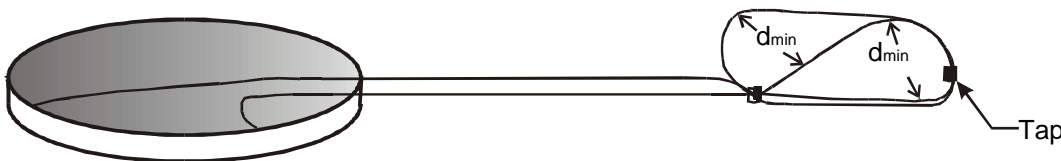

Step 3. Roll teardrop into coil and tape.

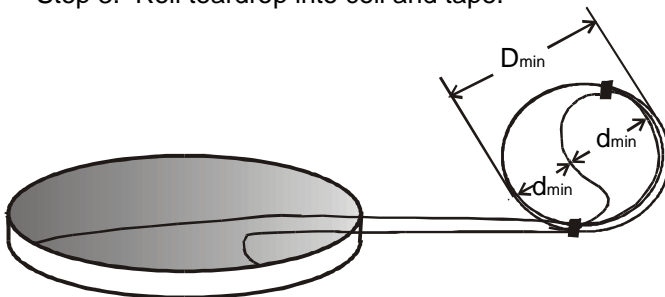

Step 4. Roll up the remaining cable twist free. Note: D_{min} = the **larger** of $2 \times d_{min}$ or the minimum coil diameter listed in Table 1. In some cases, D_{min} may be larger than the minimum coil diameter recommended in Table 1.

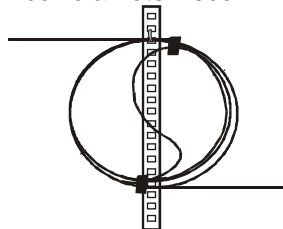

Step 5. Use cable ties to hang in manhole. Note: In a straight-through manhole, the cable will come off the top and bottom of the coil.

Figure 14 - Teardrop Method

9.4 Garden Hose Method

The garden hose method (Figure 15) is recommended for large diameter cables because only one turn of cable is handled at a time. The storage coil can be formed directly on the manhole racking as each additional loop is added. Each loop can be taped in place as it is added to the storage coil. This method can be used to store any length of slack cable.

To form a twist-free coil, alternate left- and right-hand turns of cable are added to the coil. The alternating turns are formed by twisting the cable in alternate directions during the coiling process. **Caution: Failure to alternate the direction of the cable turns may cause severe cable twisting and possible cable damage.**

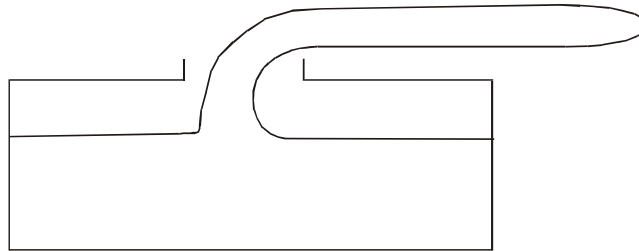

Step 1. Lay out the cable slack.

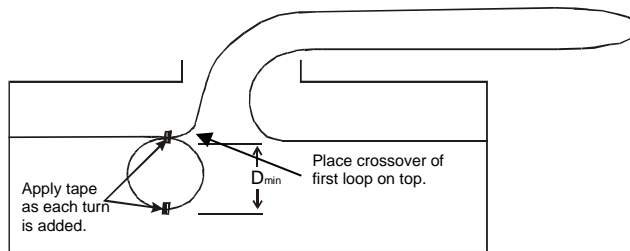

Step 2. Form the first turn in the cable. See Table 1 for the minimum storage-coil diameter (D_{min}).

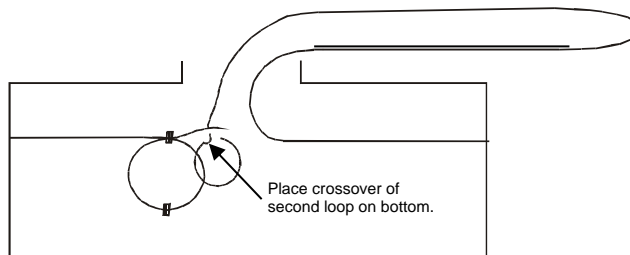

Step 3. Add the second turn by twisting the cable in the opposite direction to form the loop. The crossover point of the second turn should be on the bottom of the loop.

Step 4. Repeat Steps 2 and 3 until all the cable slack has been placed in the coil. Add successive left- and right-hand turns by twisting the cable in the opposite direction for each successive loop. **Caution: Continuous twisting of the cable in the same direction may cause excessive twist and cable damage.**

Figure 15 - Garden Hose Method

9.5 Coils Stored at Splice Locations

Slack cable must be stored at splice locations to allow for splicing. Typically, a cable length of 50 to 100 feet is required for splicing purposes; however, the actual cable length may vary depending on the accessibility of the manhole. Following cable placement, the cable ends should be capped and excess innerduct should be cut and removed. Slack cable at the splice locations should always be stored using the coiling method shown in Figure 16.

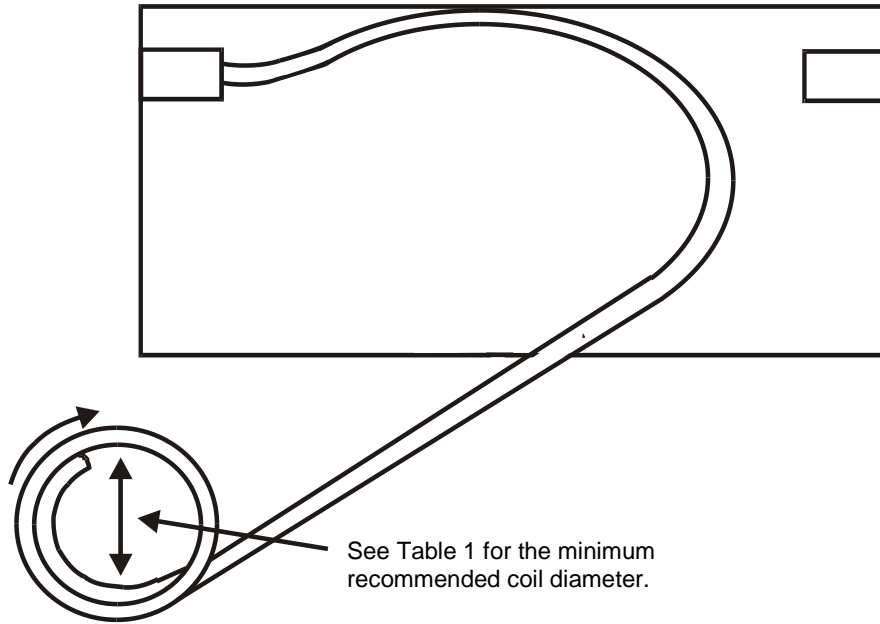

Figure 16 - Coiling slack cable at a splice location.

Prior to splicing, the two cable ends should be removed from the manhole and straightened as shown in Figure 17. Be sure to maintain the minimum bend diameter of the cables when organizing them in the manhole. The cables should be secured together along their lengths using vinyl tape or cable ties and the cable ends should be cut flush in preparation of splicing.

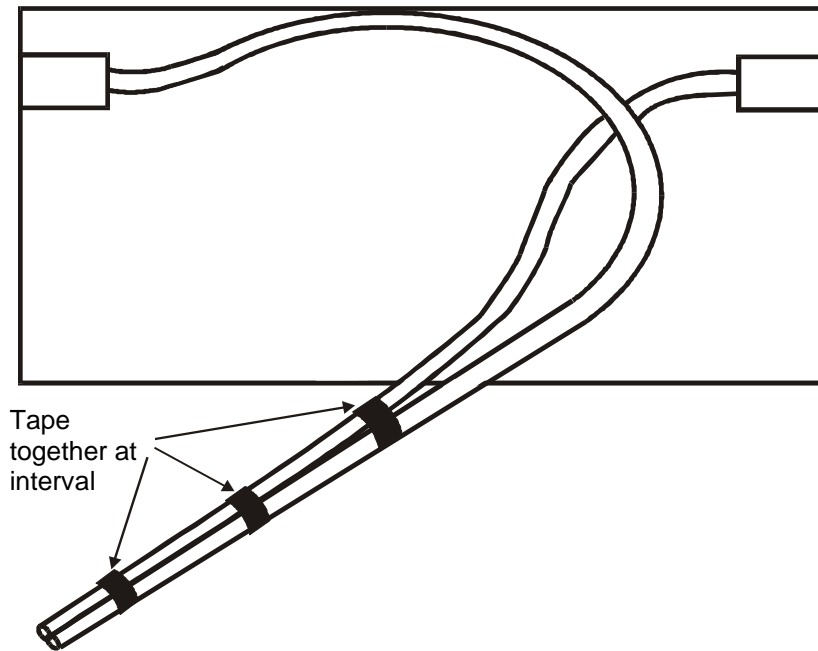

Figure 17 - Routing Cables at Splice Point

Slack cable should be coiled and stored in handholes as shown in Figures 18 – 19.

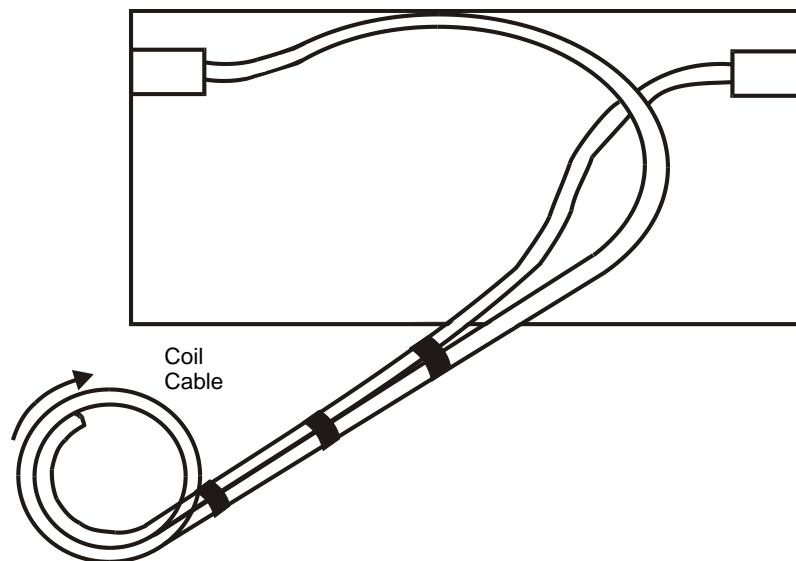

Figure 18 - Coiling cable slack at splice location.

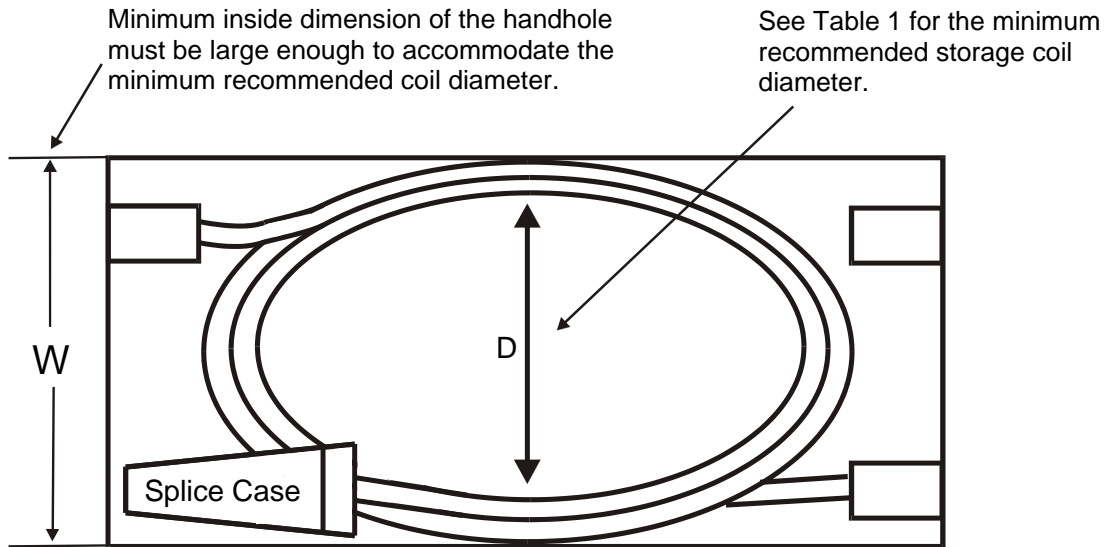

Figure 19 - Storing slack cable and splice closure.

10. Racking Fiber Optic Cable and Innerduct

Cable racking normally begins in intermediate manholes and proceeds manhole by manhole toward each end of the cable. Slack for racking the fiber optic cable may come from either the feed or the pull manhole depending on which end is closer and the amount of excess cable that is available. The preferred method of obtaining racking slack is pulling by hand. If the cable cannot be moved by hand, a split cable grip can be attached to the cable and the cable can be pulled using a cable winch or a chain hoist. Do not exceed the maximum tension rating or violate the minimum bending diameter of the cable while pulling the slack.

In the intermediate manholes, it is preferable to leave the innerduct continuous through the manhole. The innerduct will provide the cable with an extra layer of protection during future work activities. The innerduct and enclosed cable can be pushed against existing cables or manhole racks and secured with plastic cable ties. If there is not enough slack to rack the innerduct, the innerduct should be cut. Pulling slack innerduct from adjacent manholes is not recommended. If the innerduct is cut, the ends of the innerduct should extend beyond the first vertical rack so they can be secured at that point. Cable that is not enclosed in the innerduct can be secured to the manhole racks with plastic cable ties. Where necessary, the cable should be protected and/or supported with split pipe. If the innerduct does not reach the first cable rack, a duct shoe should be used to support the cable at the exit of the innerduct to prevent the cable from being sharply bent or kinked.

Cable coils should be racked in a location where they will not be damaged, preferably on the manhole wall behind in-place cables. Do not decrease the diameter of the cable coils. If slack cable must be removed from the coil for racking purposes, remove one or more loops from the coil and then enlarge the coil to absorb excess slack. Tie the coil securely in place with plastic ties.

For additional information please contact your sales representative. You can also visit our website at www.ofsoptics.com or call 1-888-FIBERHELP (1-888-342-3743) from inside the USA or 1-770-798-5555 from outside the USA.

AccuRibbon, AccuTube, DuctSaver, LightPack, and DryBlock are registered trademarks, and Fortex is a trademark of OFS FITEL, LLC.

OFS reserves the right to make changes to the document at any time without notice. This document is for informational purposes only and is not intended to modify or supplement any OFS warranties or specifications relating to any of its products or services. OFS makes no warranty or representation with respect to the non-OFS products or non-OFS companies mentioned in this document.

***Copyright © 2020 OFS FITEL, LLC.
All rights reserved, printed in USA.***