



A Furukawa Company

Your Optical Fiber Solutions Partner™

## Crimp & Cleave Termination Instructions

for 400  $\mu\text{m}$  V-Pin Connectors



### For Use With:

400  $\mu\text{m}$  V-System® Termination Kit

400  $\mu\text{m}$  HCS® Fiber-Optic Cable

V-Pin 400 Crimp & Cleave Connectors

## Important Safety and Warranty Information

---

### Please Read First

Please make sure to **READ** and understand termination instructions completely. Improper assembly will cause poor termination results and cause damage to termination kit components.

Make sure you **WEAR** eye protection during the cleaving process. The bare fiber is sharp and may splinter; handle very carefully. Make sure fiber is disposed of properly, in a hard-sided container.

OFS Specialty Photonics Division **WARRANTS** this termination kit to be free of defects for a period of 90 days from the date of purchase. Each kit is qualified at our factory prior to shipment. OFS Specialty Photonics Division will, at their discretion, repair or replace any tools found to be defective due to workmanship within the stated warranty period. (Excludes damage to the fiber stripper, cleave tool, and/or diamond blade due to misuse.)

OFS Specialty Photonics Division recommends that all replacements or repairs be made at our manufacturing facility, except where specifically outlined. Please **CONTACT** the sales representative in your region or call the factory for technical support:

Mon-Friday, 8:00 am-5:00 pm EST.

**888-438-9936** [Toll free in the US and Canada]

**860-678-0371** [International]

# Table of Contents

Content	Page
400 µm V-System Termination Kit Contents . . . . .	1
Related Products and Accessories . . . . .	2
V-Pin Connectors . . . . .	2
 <b>Termination Instructions</b>	
Step 1: Strip cable outer jacket . . . . .	3-4
Step 2: Install crimp ring . . . . .	5-6
Step 3: Strip fiber buffer . . . . .	7-8
Step 4: Install V-Pin connector . . . . .	9
Step 5: Cleave fiber . . . . .	10-12
Step 6: Assemble duplex latch . . . . .	13-16
 Diamond Cleave Tool Diagram . . . . .	 10

Content	Page
 <b>Maintenance &amp; Trouble Shooting Guide</b>	
Importance of Cleave Tool Cleaning and Maintenance . . . . .	17
Cleave Tool Cleaning Kit . . . . .	17
Diamond Blade Replacement Kit . . . . .	17
Trouble Shooting Guide . . . . .	18
 Termination and Test Kits Available . . . . .	 19
 Trademark Information . . . . .	 Back Cover

## 400 $\mu$ m V-Pin Termination Kit Contents

### Contents

Part Numbers	Description
DT03732-34	400 $\mu$ m V-System Termination Kit
AP03739-02	400 $\mu$ m V-Pin Instruction Booklet
DT03732-04	400 $\mu$ m V-Pin Diamond Cleave Tool (Black Spring)
AP01224	Cable Stripper
BT03865-02	Crimp Tool (Yellow Handles)
CP01229-02	Fiber Stripper (Royal Blue Blade Insert) with Cleaning Brush and Prong Tool
AP01225	Scissors
K16248	Booklet: Importance of Cleave Tool Cleaning and Maintenance

*Other Items Required (not included in kit): Safety Glasses, Marker*



## Related Products and Accessories (Sold Separately)

Part Numbers	Description
P10188-02	Insertion Loss Test Kit for 400 $\mu\text{m}$ V-Pin
P10188-09	Insertion Loss Test Kit for 400 $\mu\text{m}$ V-Pin, ST, and SMA Connectors
P16247	Cleave Tool Cleaning Kit
AT03290	Diamond Blade Replacement Kit

## V-Pin Connectors (Sold Separately)

Part Numbers	Description
BP05226-01	V-Pin 400 Blue (Bag of 25)
BP05226-02	V-Pin 400 Black (Bag of 25)
AP04707	V-Pin Splice Bushing (thread size: 5/16-32 UNEF)
BP04703	Duplex Latch Connector Housing

## V-Pin Connector Parts

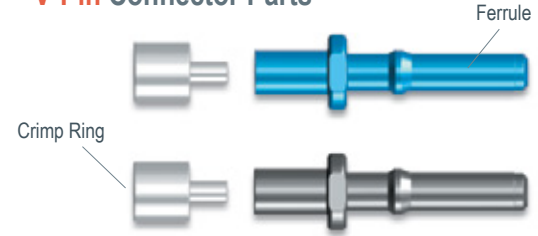

## V-Pin Connector Accessories

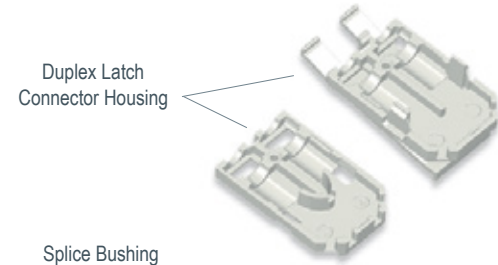

## Termination Instructions step 1

### STEP 1

#### Strip Cable Outer Jacket

- Mark cable outer jacket  $2\frac{1}{2}$  (63 mm) inches from the end with a **MARKER**.
- Select appropriate hole on **CABLE JACKET STRIP TOOL** to suit cable outer jacket diameter. (Refer to strip template below).

##### Stripping Hole Guide

Cable Size 2.2 mm  
Stripping Hole 1.6



- Using the **CABLE JACKET STRIP TOOL**, apply quick squeezing action, release and remove the  $2\frac{1}{2}$  inches of cable outer jacket.

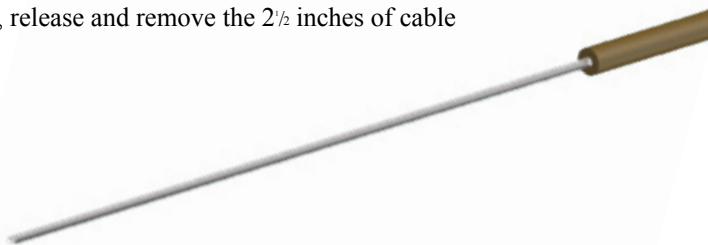

#### NOTE:

If the cable outer jacket is difficult to remove in one step, it may be removed in shorter sections.

- Verify proper strip length against the strip template shown below.

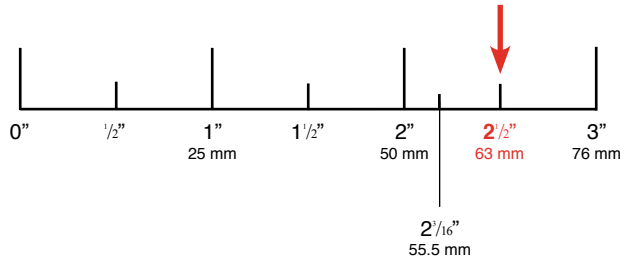

## Termination Instructions step 2

### STEP 2

#### Install Crimp Ring

- Feed fiber through CRIMP RING. Bottom out the crimp ring on the cable outer jacket using a clockwise turning motion. (i.e. screw the crimp ring onto the cable outer jacket if necessary)

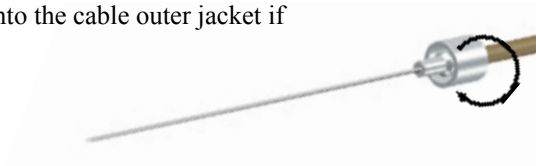

- Holding cable and crimp ring in left hand and CRIMP TOOL in right, insert small end of crimp ring completely into the front die nest of the crimp tool.



- Squeeze crimp tool handles together until it clicks, then releases.

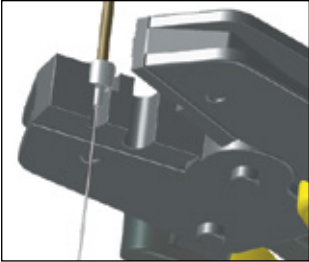

## Termination Instructions step 3

### STEP 3

#### Strip Fiber Buffer

##### **!** Before you start:

Make sure to use the appropriate strip tool insert for the buffer removal process: Royal Blue

Be careful while handling the FIBER STRIPPER. Handle as a precision device and do not strike on hard surfaces or drop.

Be sure to clean blades frequently using small bristle brush supplied.

**IMPORTANT:** Pull straight when stripping the fiber buffer. The HCS fiber cladding can be damaged if fiber is not pulled straight.

- Insert the buffered fiber through the guide tube of the fiber stripper until the cable outer jacket bottoms out in the tube.

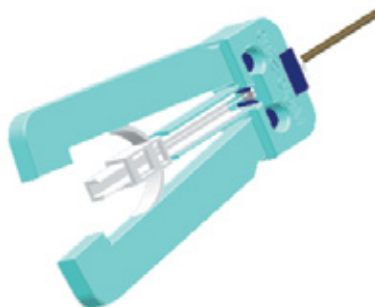

##### **NOTE:**

If unable to insert buffered fiber through guide tube, trim tip of the fiber using scissors. If a short length of cable is being terminated, wrap the cable around your finger to prevent fiber from pulling out of cable jacket.

- Holding cable securely, squeeze handles to cut buffer and **PULL STRAIGHT** to remove buffer.
- Release the buffer strip tool handles.

- Inspect HCS cladding for damage from improper buffer stripping. (i.e. white dusty stripe)

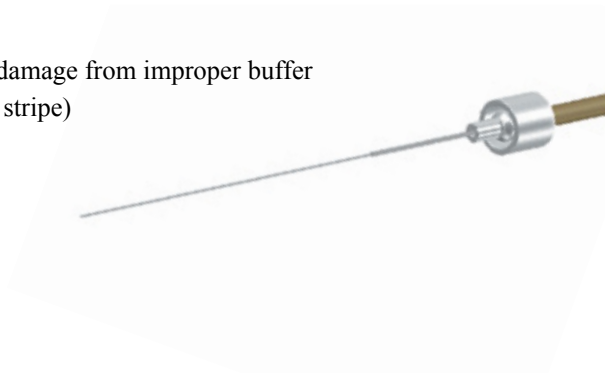

**NOTE:**

Be careful not to touch the HCS fiber coating. Once the fiber has been stripped, the coating will retain finger oils, which can transfer to and damage gripper pads in the cleaver during step 5 in the termination process.

**NOTE:**

If damage is visible, cut off the damaged fiber and repeat the procedure from step 1: Strip Cable Outer Jacket.

## Termination Instructions steps 4 & 5

### STEP 4

#### Install V-Pin Connector

- Slide the FERRULE onto the fiber, large diameter first, and push completely into the outer flange of the crimp ring.

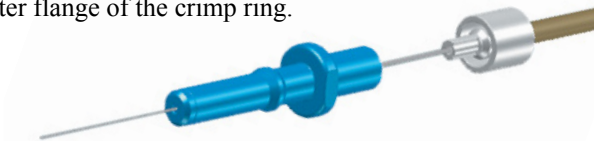

- Insert the crimp ring completely into the rear die nest of the CRIMP TOOL. Be sure the ferrule flange is flush against the edge of the die nest.



- Squeeze crimp tool handles together until it clicks, then releases.

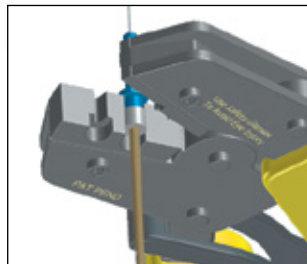

#### NOTE:

Be careful not to touch the HCS fiber coating. Once the fiber has been stripped, the coating will retain finger oils, which can transfer to and damage gripper pads in the cleaver during step 5 in the termination process.

## STEP 5

### Cleave Fiber

#### ! Before you start:

Make sure the appropriate cleave tool positioner plate is being used: **V-Pin**

Make sure the appropriate colored tension spring is being used:  
**Black**

Refer to diagram of the Cleave Tool.

Careful while handling the Cleave Tool. Handle as a precision device and do not strike on hard surfaces or drop.

Keep the cleave tool clean and free from oils, including naturally occurring finger oils. Gripper pads, diamond blade and anvil should be cleaned after every 50 cleaves. Use the OFS Cleave Tool Cleaning Kit — Part #P16247, available separately.

Do not use alcohol to clean the diamond blade or the gripper pads. Alcohol will chemically react with the gripper pads and ruin them.

Do not insert metal tools near the diamond blade, as it is fragile and may chip.

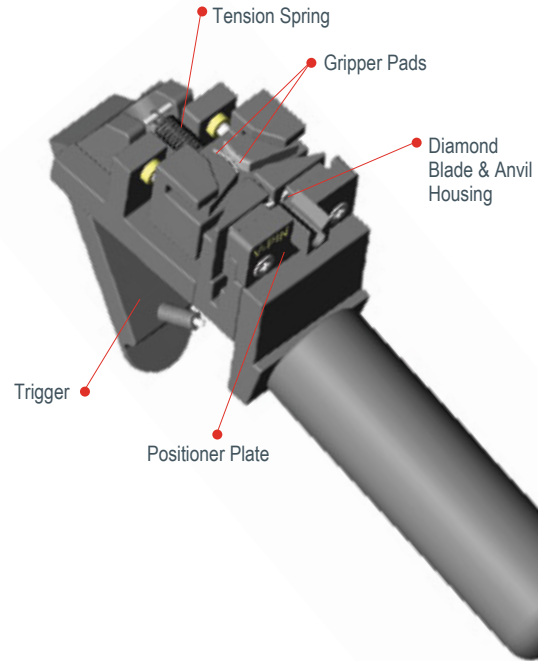

Step 5 continues onto the next page →

## Termination Instructions step 5 continued

### STEP 5

#### Cleave Fiber continued

- Holding the CLEAVE TOOL in a horizontal position, grip the handle while leaving your index finger free to actuate trigger.
- Place the ferrule into the hole of the positioner plate until it is fully inserted.
- Release the connector in the tool.

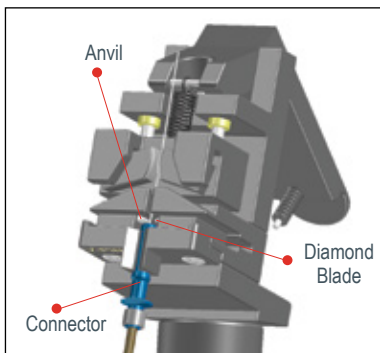

(Diagram pictured vertically to show detail.)

#### NOTE:

It is critical to fully insert the connector into the positioner plate. Failure to do so, may cause poor cleave quality and/or damage to the diamond blade.

#### NOTE:

Do not hold onto the connector during the cleave process. Doing so may cause poor cleave quality.

- Using index finger, slowly and gently depress trigger to perform the cleave process. The cleave process is complete when the fiber snaps away from the connector. Do not release the trigger!

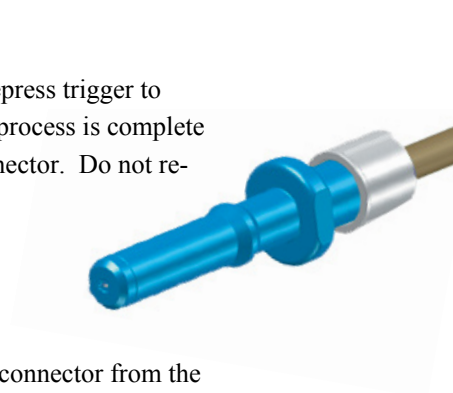

- Before releasing the trigger, remove the connector from the cleave tool and grasp the top of the scrap fiber while releasing the trigger. Gently remove the scrap fiber while keeping it away from the diamond blade.
- Dispose of scrap fiber safely in a hard-sided container.

## Termination Instructions step 6

### STEP 6

#### Assemble Duplex Latch

##### **!** Before you start:

For use with OFS' V-Pin in a zipcord configuration, for fiber organization and increased connector-to-device retention.

To ensure polarity of the assembly, use the printing on the zipcord cable for leg identification.

#### Cable Exiting Straight Out of the Rear of the Duplex Latch

- Prior to assembly into the duplex latch, the connectors should be terminated to the exact same length.
- Insert transmit and receive connectors into the bottom portion of the **DUPLEX LATCH**.

*Transmit is usually identified in the duplex latch as #1 and receive is identified as #2.*

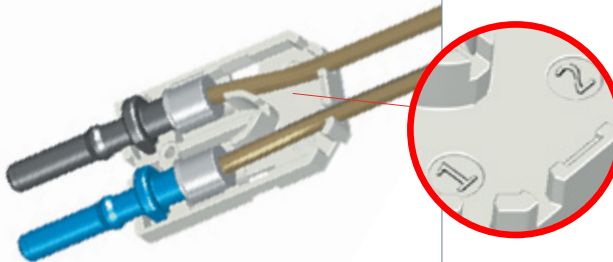



- Press jacket material into the cable channels.
- Place top (latching) portion of housing over the connector assembly and snap together.

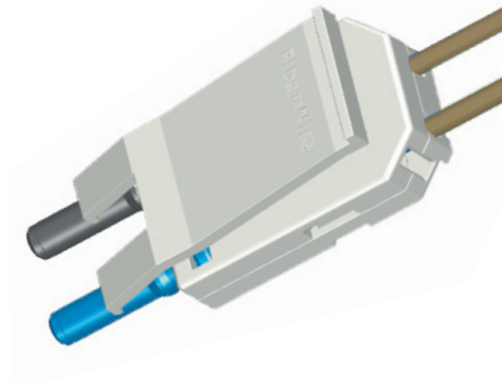

**Step 6 continues  
onto the next page →**

## Termination Instructions step 6 continued

### STEP 6

#### Assemble Duplex Latch (continued)

##### Cable Exiting at a Right Angle Out of the Duplex Latch

- Based upon which direction the cable is to exit the duplex latch, terminate the connectors with a 0.25" length differential.

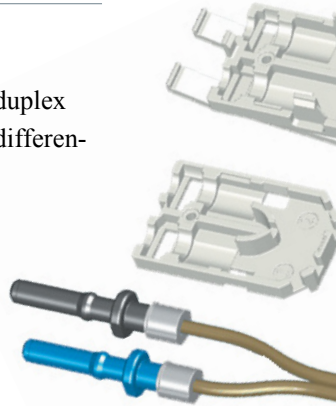

- Insert the connectors into the bottom portion of the duplex latch with the longer leg in the position opposite the exit point.

- Press the short leg cable material through the right angle cable channel.

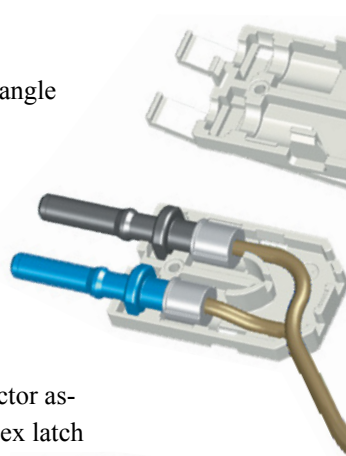

- Place top (latching) side of housing over the connector assembly and press the longer leg into the upper duplex latch half.



## Maintenance & Trouble Shooting Guide

---

### Importance of Cleave Tool Cleaning and Maintenance

The Cleave Tool supplied with OFS's Termination Kits contains movable parts, wear items, and a diamond blade that require regular maintenance, care, or replacement after useful life in order to perform satisfactorily. Damage and parts replacement expense can result if recommended procedures are not followed.

- ~ The diamond blade must be cleaned; the gripper pads must be cleaned, kept oil-free, and replaced after wear.
- ~ The cleave-tool trigger must be depressed slowly.
- ~ Fiber must be kept perpendicular to the diamond blade.

### Cleave Tool Cleaning Kit

For cleaning your cleave tool, please order the OFS Cleave Tool Cleaning Kit (part #P16247) which includes recommended cleaning fluid, swabs, and complete instructions.

### Diamond Blade Replacement Kit

For replacing the diamond blade/anvil assembly, please order the Diamond Blade Replacement Kit (Part #AT03290.) The kit includes a new diamond blade, anvil, replacement screws, and complete instructions for performing this simple procedure at your facility.

## Trouble Shooting Guide

Problem	Dim-light termination/ no light termination	Poor cleave quality / High insertion loss	Fiber does not cleave	Fiber protrudes or recesses after cleave
Possible Explanations	<p>Improper strip technique <i>Refer to Steps 1 &amp; 3</i></p> <p>Improper crimp position <i>Refer to Steps 2 or 4 - 6</i></p>	<p>Improper crimp position <i>Refer to Steps 2 or 4 - 6</i></p> <p>Improper cleave techniques <i>Refer to Step 5</i></p> <p>Incorrect tooling for fiber size or connector type <i>Refer to Page 1</i></p> <p>Diamond blade needs to be cleaned or replaced <i>Refer to Page 17</i></p> <p>Gripper pads worn and need to be replaced <i>Call Tech Support to place a purchase order for service.</i></p>	<p>Fiber has not been first thoroughly stripped <i>Refer to Step 3</i></p> <p>Improper cleave techniques <i>Refer to Step 5</i></p> <p>Incorrect tooling for fiber size or connector type <i>Refer to Page 1</i></p> <p>Diamond blade needs to be cleaned or replaced <i>Refer to Page 17</i></p> <p>Gripper pads worn and need to be replaced <i>Call Tech Support to place a purchase order for service.</i></p>	<p>Improper crimp position <i>Refer to Steps 2 or 4 - 6</i></p> <p>Improper cleave techniques <i>Refer to Step 5</i></p> <p>Incorrect tooling for fiber size or connector type <i>Refer to Page 1</i></p> <p>Gripper pads worn and need to be replaced <i>Call Tech Support to place a purchase order for service.</i></p>

If you are still experiencing problems, please call for Technical Support 888 438 9936 (US & Canada) or 860 678 0371

## Termination and Test Kits Available

---

OFS offers a specialized Termination Kit—and associated Insertion Loss Test Kit—for each type of Crimp & Cleave connector we support. These kits are available in various combinations of sizes and/or connector types. Customer Relations at our factory can help you select the correct kit for your purposes.

This document is for informational purposes only and is not intended to modify or supplement any OFS warranties or specifications relating to any of its products and services.

Copyright © 2014 OFS Fitel, LLC.  
All Rights Reserved.

0814



55 Darling Drive, Avon, CT 06001

**To learn more, please call or visit our website.**

Phone: **1 860 678 0371**

Toll Free: **1 888 438 9936**

Web: **[www.ofsoptics.com](http://www.ofsoptics.com)**

**AP03769-02 Rev. K**

## **Trademark Information:**

Manufactured in the USA by OFS.

V-System is a registered trademark of OFS Fitel, LLC.

HCS is a registered trademark in the USA of OFS Fitel, LLC.